



Homeowner's Guide to Retrofitting

Six Ways to Protect Your Home From Flooding

FEMA P-312, Second Edition / December 2009



FEMA

Homeowner's Guide to Retrofitting

Six Ways to Protect Your Home From Flooding

FEMA P-312, Second Edition / December 2009



FEMA

Table of Contents

Chapter 1

1.0	About This Guide	1-1
1.1	Who This Guide Is For	1-1
1.2	How This Guide Can Help You.....	1-1
1.3	How To Use This Guide.....	1-2

Chapter 2

2.0	Introduction to Retrofitting	2-1
2.1	Introduction	2-1
2.2	What is “Retrofitting”?	2-3
2.3	Types of Flooding	2-3
2.4	How Flooding Can Damage Your Home	2-5
	2.4.1 Depth/Elevation of Flooding.....	2-6
	2.4.2 Flow Velocity.....	2-8
	2.4.3 Flood Frequency	2-10
	2.4.4 Rates of Rise and Fall.....	2-11
	2.4.5 Duration	2-11
	2.4.6 Debris Impact.....	2-12
2.5	Other Hazards	2-12
2.6	Federal, State, and Local Regulations	2-13
	2.6.1 The Community Rating System.....	2-15
	2.6.2 Flood Insurance Rate Maps.....	2-15
2.7	Financial Assistance for Retrofitting	2-17
	2.7.1 Federal Programs	2-17
	2.7.2 Non-Federal Help	2-21

Chapter 3

3.0	An Overview of the Retrofitting Methods	3-1
3.1	Introduction	3-1
3.2	Cautions	3-2
3.2.1	Substantial Improvement/Substantial Damage	3-2
3.2.2	Basements.....	3-3
3.2.3	Design Flood Elevation and Risk	3-4
3.2.4	Freeboard	3-5
3.2.5	Human Intervention.....	3-7
3.2.6	Other Considerations	3-7
3.3	Construction Terminology	3-9
3.3.1	Construction Type.....	3-9
3.3.2	Foundation Type	3-10
3.4	Retrofitting Methods and Costs	3-11
3.4.1	Elevation	3-12
3.4.2	Wet Floodproofing.....	3-21
3.4.3	Relocation.....	3-25
3.4.4	Dry Floodproofing	3-29
3.4.5	Levees and Floodwalls.....	3-32
3.4.6	Demolition.....	3-38
3.5	Summary	3-40

Chapter 4

4.0	Deciding Which Method Is Right for Your Home	4-1
4.1	Introduction	4-1
4.2	Making Your Decision	4-2
4.2.1	Step 1 – Determine the Hazards to Your Home.....	4-2
4.2.2	Step 2 – Inspect Your Home	4-2
4.2.3	Step 3 – Check with Your Local Officials.....	4-11
4.2.4	Step 4 – Consult a Design Professional and Retrofitting Contractor	4-12

4.3	Retrofitting Checklist.....	4-16
4.4	Decision-Making Matrices	4-26
4.4.1	Condition: Substantial Improvement/Substantial Damage.....	4-26
4.4.2	Condition: NOT Substantial Improvement/NOT Substantial Damage.....	4-28

Chapter 5

5.0	Elevating Your Home	5-1
5.1	Introduction	5-1
5.2	Considerations	5-2
5.2.1	Amount of Elevation.....	5-2
5.2.2	Existing Foundation.....	5-4
5.2.3	Hazards.....	5-5
5.2.4	Access.....	5-5
5.2.5	Home Size, Design, and Shape	5-6
5.2.6	Service Equipment.....	5-6
5.3	The Elevation Techniques	5-7
5.3.1	Elevating on Extended Foundation Walls.....	5-7
5.3.2	Alternative Elevation Techniques for Masonry Homes on Slab-on-Grade Foundations.....	5-14
5.3.3	Elevating on an Open Foundation	5-18

Chapter 6

6.0	Wet Floodproofing	6-1
6.1	Introduction	6-1
6.2	Considerations	6-2
6.2.1	Design Flood Elevation	6-2
6.2.2	Hazards.....	6-2
6.2.3	Post-Flood Cleanup.....	6-3
6.3	Modifications Required for Wet Floodproofing	6-4
6.3.1	Installing Openings.....	6-4

6.3.2 Using Flood Damage-Resistant Materials6-7
 6.3.3 Protecting Service Equipment6-8

Chapter 7

7.0 Relocation and Other Methods7-1
 7.1 Introduction 7-1
 7.2 Relocation 7-1
 7.2.1 Introduction 7-1
 7.2.2 Considerations 7-2
 7.2.3 The Relocation Process 7-3
 7.3 Dry Floodproofing 7-8
 7.3.1 Introduction 7-8
 7.3.2 Considerations 7-8
 7.3.3 Modifications Required for Dry Floodproofing..... 7-11
 7.4 Levees and Floodwalls 7-17
 7.4.1 Introduction 7-17
 7.4.2 Considerations 7-18
 7.4.3 Levee Construction 7-24
 7.4.4 Floodwall Construction..... 7-25
 7.4.5 Temporary Flood Barriers 7-26
 7.5 Demolition 7-27
 7.5.1 Introduction 7-27
 7.5.2 Considerations 7-28
 7.5.3 The Demolition Process 7-29

Chapter 8

8.0 Protecting Service Equipment8-1
 8.1 Introduction 8-1
 8.2 Methods of Protection 8-2
 8.2.1 Elevation 8-2

8.2.2	Relocation.....	8-4
8.2.3	Protection in Place.....	8-4
8.2.4	Anchors and Tiedowns	8-5
8.2.5	Backflow Valves	8-7

Appendices

Appendix A.	Bibliography and Sources of Information	A-1
Appendix B.	Acronyms and Glossary.....	B-1
Appendix C.	FEMA Offices	C-1
Appendix D.	NFIP State Coordinating Agencies	D-1
Appendix E.	State Historic Preservation Offices	E-1
Appendix F.	Professional Organizations	F-1

Figures

Chapter 2

Figure 2-1.	This home near Atlanta was flooded several times. During the largest flood, the water reached as high as 2 feet above the first floor.....	2-2
Figure 2-2.	The home was elevated in a way that added to both its appearance and its value.	2-2
Figure 2-3.	Now the home (in the background) is protected from flooding, unlike the flooded home in the foreground.....	2-2
Figure 2-4.	This home in Wisconsin was inundated by riverine flooding.	2-5
Figure 2-5.	The extreme impact of large, fast-moving waves, combined with the removal of supporting soil by erosion and scour, can have devastating effects.....	2-5
Figure 2-6.	In this example, the 1-percent annual chance flood elevation is 391.6 feet (10.1 feet above the benchmark elevation of 381.5 feet).....	2-7
Figure 2-7.	Hydrostatic pressure acts on walls and concrete slab floors. The weight of saturated soils adds to the pressure on basement walls.	2-7
Figure 2-8.	The walls of this basement in Iowa failed because of the pressure exerted by water and saturated soil.	2-8
Figure 2-9.	Once water enters the home, hydrostatic pressure is equalized.	2-8
Figure 2-10.	Moving water acts on the front, sides, and back of a home.	2-9

Figure 2-11. Moving water can cause walls to collapse, as illustrated by this riverine flood damage in Georgia..... 2-10

Figure 2-12. Wind forces on a sealed building and on a building with an opening..... 2-13

Figure 2-13. Earthquake forces act in both horizontal and vertical directions. 2-13

Figure 2-14. This portion of a FIRM shows the SFHA, 0.2-percent annual chance floodplain, floodway, BFEs, and insurance rate zones..... 2-16

Chapter 3

Figure 3-1. Typical cross-sections of three common construction types: frame, masonry veneer, and masonry. 3-10

Figure 3-2. Home foundation types. 3-11

Figure 3-3. Typical cross-section of home elevated on continuous foundation walls. 3-14

Figure 3-4. Retrofitted home elevated on extended continuous foundation walls. 3-14

Figure 3-5. This coastal home was elevated on piles so that it is less vulnerable to damage from coastal flooding..... 3-16

Figure 3-6. The owner of this flood-prone home in south Florida decided to build a new wood-framed second story on top of his masonry first story. 3-17

Figure 3-7. A home with a wet floodproofed subgrade basement. 3-22

Figure 3-8. A home with a wet floodproofed enclosure. 3-23

Figure 3-9. A typical dry floodproofed home..... 3-29

Figure 3-10. A home protected by levee (left) and floodwall (right)..... 3-34

Figure 3-11. A home protected by levee, which holds back the floodwaters shown in the lower half of the photograph. 3-34

Figure 3-12. A home protected by a floodwall designed as a landscaping feature. 3-36

Figure 3-13. Floodwall and levee dimensions for approximate costs in Table 3-14..... 3-37

Chapter 4

Figure 4-1. Peak gust wind speeds in the United States. 4-4

Figure 4-2. Earthquake hazards in the United States. 4-6

Figure 4-3. Differences between flood level and lowest floor in homes on crawlspace and basement foundations. 4-8

Chapter 5

Figure 5-1. The lowest floor is above the flood level. When at least 1 foot of freeboard is provided, only the foundation is exposed to flooding. 5-3

Figure 5-2.	This home in Cedar Falls, Iowa, was elevated one full story. The garage and storage area are at the home’s original elevation.	5-4
Figure 5-3.	With attention to detail and planning, homeowners have created attractive retrofitted homes.	5-6
Figures 5-4a – 5-4d.	Elevating a basement or crawlspace foundation home on extended foundation walls.	5-8
Figure 5-5.	Cross-section view of slab-on-grade foundation variations.	5-10
Figures 5-6a – 5-6d.	Elevating a slab-on-grade home with the slab attached.	5-11
Figure 5-7.	Elevating a slab-on-grade home without the slab.	5-13
Figure 5-8.	Building a new foundation for a slab-on-grade home.	5-13
Figures 5-9a – 5-9c.	Elevating by extending the walls of a solid masonry home.	5-15
Figures 5-10a – 5-10c.	Home elevated by adding a new second story over an abandoned lowest floor.	5-17
Figures 5-11a – 5-11d.	Elevating a basement or crawlspace foundation home on piers.	5-19
Figure 5-12.	Home elevated on post or column foundations.	5-21
Figure 5-13.	Home elevated on piles.	5-21
Chapter 6		
Figure 6-1.	A typical use of wet floodproofing.	6-3
Figure 6-2.	Wall openings must allow floodwaters not only to enter the home, but also to rise and fall at the same rate as floodwaters outside the home.	6-5
Figure 6-3.	Typical enclosures with flood openings.	6-6
Chapter 7		
Figure 7-1.	When a home is too large to be moved in one piece, it may have to be cut into sections that can be moved separately and then reassembled at the new site. ...	7-3
Figure 7-2.	Trailer wheel sets are placed beneath the lifting beams.	7-6
Figure 7-3.	The move to the new site begins.	7-6
Figure 7-4.	After the home is raised into place, the foundation is completed.	7-7
Figure 7-5.	The hydrostatic pressure exerted by floodwater (including buoyancy) increases with depth.	7-9
Figure 7-6.	The lateral and buoyancy force resulting from the same depth of flooding is much less on a home without a basement than on a home with a basement.	7-10

Figure 7-7.	A 12-inch high asphalt coating was added to this brick wall.	7-12
Figure 7-8.	New brick veneer added over asphalt coating.....	7-12
Figure 7-9.	In the “wrapped home” method, the lower portion of the home is protected with a temporary layer of polyethylene film.....	7-13
Figure 7-10.	Heavy-gauge metal shield over sliding glass door opening.	7-14
Figure 7-11.	Light-gauge metal shield held in place by permanently installed tracks.....	7-15
Figure 7-12.	Low window raised approximately 2 feet and original opening filled with brick.	7-15
Figure 7-13.	Drainage system for a dry floodproofed home.	7-16
Figure 7-14.	Cross-sections of a typical 3-foot high levee, 6-foot high levee, and 4-foot high floodwall.....	7-20
Figure 7-15.	Hydrostatic pressure in saturated soils poses a threat to homes behind levees, especially homes with basements	7-21
Figure 7-16.	Closure panels for floodwalls.	7-22
Figure 7-17.	An access staircase over a low floodwall.....	7-23
Figure 7-18.	Levees are constructed with compacted layers of soil	7-24
Figure 7-19.	Gravity and cantilever floodwalls.	7-26
Figure 7-20.	Typical brick-faced concrete floodwall. Detail shows cross-section through wall.	7-26
Figure 7-21.	Typical mitigation reconstruction project.....	7-30

Chapter 8

Figure 8-1.	Air conditioning/heat pump compressor mounted on a brick pedestal outside an elevated home.	8-2
Figure 8-2.	Air conditioning/heat pump compressor mounted on a cantilevered platform attached to a home elevated on an open foundation.....	8-3
Figure 8-3.	Water heater and furnace protected by a concrete floodwall with opening and gasketed shield.	8-5
Figure 8-4.	Anchoring a fuel storage tank with a concrete slab.....	8-6
Figure 8-5.	Dual backflow valve installed in an exterior valve pit.	8-8

Tables

Chapter 2

Table 2-1.	Eligible Retrofit Activities by Program.....	2-20
------------	--	------

Chapter 3

Table 3-1.	Advantages and Disadvantages of Elevation.....	3-18
Table 3-2.	Relative Costs of Elevating a Home	3-19
Table 3-3.	Approximate Square Foot Costs of Elevating a Home (2009 Dollars)	3-20
Table 3-4.	Advantages and Disadvantages of Wet Floodproofing.....	3-23
Table 3-5.	Relative Costs of Wet Floodproofing.....	3-25
Table 3-6.	Approximate Costs of Wet Floodproofing (2009 Dollars)	3-25
Table 3-7.	Advantages and Disadvantages of Relocation	3-27
Table 3-8.	Relative Costs of Relocation	3-28
Table 3-9.	Approximate Costs of Relocation (2009 Dollars)	3-28
Table 3-10.	Advantages and Disadvantages of Dry Floodproofing.....	3-31
Table 3-11.	Approximate Costs of Dry Floodproofing (2009 Dollars).....	3-32
Table 3-12.	Advantages and Disadvantages of Levees and Floodwalls	3-35
Table 3-13.	Relative Costs of Levees and Floodwalls	3-36
Table 3-14.	Approximate Costs of Levees and Floodwalls (2009 Dollars)	3-37
Table 3-15.	Approximate Costs of Mitigation Reconstruction (2009 Dollars)	3-39
Table 3-16.	Relative Costs of Various Retrofit Measures	3-41

Chapter 4

Table 4-1.	Requirements for Design Professional and Contractor Services	4-14
Table 4.2.	Retrofitting Methods for Substantially Improved or Substantially Damaged Homes.....	4-27
Table 4.3.	Retrofitting Methods for Homes That are NOT Substantially Improved or Damaged	4-29

Chapter 6

Table 6-1.	Flood Damage-Resistant Materials.....	6-8
------------	---------------------------------------	-----

1.0 About this Guide

1.1 Who This Guide Is For

The Federal Emergency Management Agency (FEMA) has prepared this guide specifically for homeowners who want to know how to protect their homes from flooding. As a homeowner, you need clear information about the options available to you and straightforward guidance that will help you make decisions. This guide gives you both, in a form designed for readers who have little or no experience with flood protection methods or building construction techniques.

If you are an engineer, an architect, a construction contractor, or someone with skills in those fields, you may want to ask FEMA for copies of technical manuals that cover design and construction in greater detail. For example, all of the flood protection methods described in this guide are discussed in depth in FEMA 259, *Engineering Principles and Practices for Retrofitting Flood-Prone Residential Structures*. If you work in a coastal area, FEMA 550, *Recommended Residential Construction for Coastal Areas: Building on Strong and Safe Foundations*, and FEMA 55, *Coastal Construction Manual* may also be useful. If you would like to obtain copies of these documents or other FEMA documents referred to in this guide free of charge, you can download them from the FEMA website (<http://www.fema.gov/library/irlSearchFemaNumber.do>) or call the FEMA Publications Service Center at 1-800-480-2520. See Appendix A for a list of documents concerning flood protection prepared by FEMA and other agencies and organizations.



DEFINITION

The Federal Emergency Management Agency (FEMA) is an agency within the Department of Homeland Security (DHS) that administers the National Flood Insurance Program (NFIP). The NFIP is the Federal program, created by Congress in 1968, that makes flood insurance available in communities that adopt and enforce floodplain management ordinances or laws that meet the minimum requirements of the NFIP regulations.

1.2 How This Guide Can Help You

You should take steps to protect your home if it has been damaged by flooding or is in an area where flooding is likely to occur. But first, you need to know what methods are available, how they work, how much they may cost, and whether they will meet your specific needs. This guide covers all of those issues. It also explains flood hazards and how they can damage your home. Don't forget that flooding is only one of several natural hazards that may threaten your home. This guide includes maps that will help you determine whether your home is in an area where earthquakes or high winds occur, and it also explains when your retrofitting project should include protection against these hazards.

Your State and local governments probably have adopted building codes and other rules and regulations that you will need to know about. This guide points you in the right direction by explaining how your **local officials** can advise you. Regardless of the flood protection method you choose, you may wish to consult with a licensed architect, engineer, or trades person for assistance with some of the retrofitting measures described in this guide. This guide describes the types of services you can expect design professionals and contractors to provide.

1.3 How To Use This Guide

To get the most from this guide, you should first read Chapters 2, 3, and 4. Chapter 2 explains “retrofitting” and, by describing how flood, wind, and earthquake forces can damage your home, it helps you understand how retrofitting works. Chapter 2 also provides a discussion of Federal, State, and local financial assistance programs that may help pay for your retrofitting project. Chapter 3 provides short descriptions of the six flood protection methods covered by this guide. It gives you the information you will need as you begin to think about how to protect your home, including the approximate costs, advantages, and disadvantages of each method. Chapter 4 leads you through four steps that will help you decide which method is best for you. Chapter 4 also explains how to work with local officials, design professionals, and contractors.

When you finish Chapter 4, you will be ready to focus on one method. Then you can move to Chapter 5, 6, or 7, depending on your choice. Those chapters describe the methods in greater detail and include photographs and illustrations that show how the methods are applied. Chapter 8 explains how you can protect service equipment (utility systems; heating, ventilating, and cooling (HVAC) systems; and large appliances) in conjunction with the retrofitting method you have chosen.

As you read this guide, you will often find information in the margins of pages – definitions (like the one above), notes, and warnings. Each is identified by a special symbol:



DEFINITION

In this guide, the term **local officials** refers to the employees of your community who are responsible for floodplain management, zoning, permitting, building code enforcement, and building inspection. The responsibilities of local officials vary from one community to the next. In your community, you may need to work with one or more of the following: floodplain administrator, building official, city engineer, and planning and zoning administrator.



DEFINITION – The meaning of a technical or other special term. Where a term is first used in the text, it is shown in bold type and the definition is provided in the margin. You can also find these and other definitions in Appendix B.



NOTE – Supplemental information you may find helpful, including things to consider as you plan your retrofitting project, suggestions that can make the retrofitting process easier, and the titles and sources of other publications related to flood protection and retrofitting.



WARNING – Critical information that will help you avoid mistakes that could result in dangerous conditions, violations of your community’s ordinances or laws, and possibly delays and higher costs in your retrofitting project. Be sure to read these warnings. If you are unsure about what a specific warning means or what to do to avoid the problem it describes, consult your local officials. Chapter 4 provides information about working with local officials.

A final note before you begin Chapter 2: No guide or other document of this type can anticipate every retrofitting situation or every concern a homeowner may have about undertaking a retrofitting project. If you have questions that this guide does not answer, consult your local officials. Other resources include:

- FEMA’s Building Science Helpline, a technical assistance hotline, at (866) 927-2104 (phone) or FEMA-Buildingsciencehelp@dhs.gov (email).
- If FEMA has set up a Disaster Recovery Center (DRC) in your area in response to a Presidential Declaration of a Major Disaster, members of the DRC Mitigation staff can answer questions and advise you. You may call the FEMA Helpline at 1-800-621-3362 for the location of a DRC in your area.
- Appendix A of this guide, which lists helpful publications from FEMA and other organizations.
- The FEMA web site, <http://www.fema.gov>, which has information about all of these resources and more.
- The staff members of the FEMA Regional Office for your State (see Appendix C).
- Your State NFIP Coordinator (see Appendix D) and State Historic Preservation Office (see Appendix E).



NOTE

Many government agencies, including FEMA, and non-profit organizations, maintain sites on the Internet where you can find information about flooding, high winds, earthquakes, and other hazards. Appendix A includes a partial list of sites that were operable at the time this guide was prepared.

2.0 Introduction to Retrofitting

2.1 Introduction

Every year, flooding causes an average of over 90 percent of the disaster-related property damage in the United States and accounts for an average of over 75 percent of all Presidential disaster declarations. In fact, between 1997 and 2007, the National Flood Insurance Program (NFIP) paid an average of over \$2.3 billion a year in flood claims. In 2005 alone, the NFIP paid over \$17 billion in flood claims.

Although recent improvements in construction practices and regulations have made new homes less prone to flood damage, many existing homes continue to be repetitively damaged by flooding. In fact, repetitive loss records account for 30 percent of all claim payments made in the history of the NFIP. Between 1978 and 2004, over 112,000 homes were flooded more than once. These homes alone accounted for over \$5.1 billion in flood damages, subjecting the owners to a cycle of flooding and repairing.

The good news is that there are ways to break this cycle of repetitive flood damage. Homeowners across the country have protected their homes from flooding using the techniques described in this guide. One example can be found in the Atlanta area, where some residential neighborhoods built in the 1960s were repeatedly flooded by a nearby stream (Figures 2-1 through 2-3).

One family decided to take action after their home flooded a second time. They hired a contractor who elevated the home on concrete piers so that it would be above the level of future, similar floods.

At the outset of the project, the homeowners were concerned about how the home would look after it was elevated. But once construction was complete, the concerns proved groundless. Below the elevated home, traditional latticework was installed in the spaces between the support columns. Access to the front door is now provided by a well-designed double staircase that also serves as an architectural focal point. In addition



NOTE

Any retrofitting project you undertake must meet the legal requirements of your community, including the floodplain management ordinances your community adopted to participate in the NFIP. By enforcing these ordinances, your community helps reduce future flood damages. As explained later in this chapter, the ordinances are based on the 1-percent annual chance flood, also referred to as the “base flood.” Remember these terms; you will encounter them many times as you read this guide. For more information, see Section 2.6.

Figure 2-1. This home near Atlanta was flooded several times. During the largest flood, the water reached as high as 2 feet above the first floor.



Figure 2-2. The home was elevated in a way that added to both its appearance and its value.



Figure 2-3. Now the home (in the background) is protected from flooding, unlike the flooded home in the foreground.



to providing protection from future floods, elevating the home created a space below that could be used for parking and storage. This retrofitting method worked so well that other property owners in the neighborhood have chosen to protect their homes the same way.

In other areas where flooding has caused repeated damage, entire homes have been moved outside the flood hazard area or protected by floodwalls and levees designed as attractive landscaping features. As you read further in this guide, you will see that it is possible to protect your home from flooding while preserving or even enhancing its attractiveness and value.

2.2 What Is “Retrofitting”?

You may be wondering what is retrofitting and why is it necessary? Retrofitting is making changes to an existing building to protect it from flooding or other hazards such as high winds and earthquakes. You have already seen an example of these changes, and you’ll learn more in the following chapters. Another reason for retrofitting is that construction technology, including both methods and materials, continues to improve, as does our knowledge of hazards and their effects on buildings. Many homes existing today were built when little was known about where and how often floods and other hazardous events would occur or how buildings should be protected. As a result, retrofitting has become a necessary and important tool in **hazard mitigation**.



NOTE

Retrofitting specifically for earthquake hazards is often referred to as “rehabilitation.”



DEFINITION

Hazard mitigation is sustained action taken to reduce or eliminate long-term risk to people and property from hazards such as floods, winds, earthquakes, and fires.

2.3 Types of Flooding

This guide focuses primarily on retrofitting for flood protection. If you decide to retrofit your home, you’ll need to be aware of other potential hazards as well, such as high winds and earthquakes. They are discussed later, but first it is important that you understand flooding – where and how it occurs, the nature of the threat it poses, and how it can affect your home.

Most of the flooding that occurs in the United States is either riverine or coastal flooding, although flooding also occurs around lakes and ponds, and in areas where storm drainage systems are not adequate. Riverine flooding, as its name implies, occurs when rivers and streams overflow their banks (Figure 2-4). Riverine floodwaters can move quite rapidly, as in a **flash flood**, or very slowly, as they often do where the land is gently sloping or flat. The primary causes of riverine flooding are rainfall and rapidly melting snow (and sometimes a combination

of both). Water from rain and rapidly melting snow eventually finds its way into stream channels. When the amount of water being carried by a stream exceeds the capacity of the stream channel, it spreads out into the area along the stream, commonly referred to as the floodplain. Usually, the homes and other buildings at greatest risk from riverine flooding are those near the stream channel, where the depths and speed of floodwaters are often greatest.

Coastal flooding, which is caused by **storm surge** and **wave action**, primarily affects coastal areas, especially those along the beachfront, but it can also affect areas around bays and can back up along rivers and streams that empty into bays. Coastal flooding is most dangerous, and causes the most severe damage, where large waves are driven inland by the wind (Figure 2-5). These wind-driven waves occur primarily along the open coast, where they can destroy homes, wash away protective dunes, and **erode** the soil, often to the extent that the ground surface is lowered several feet. But they can also move inland where the land is flat and there are no large dunes or other obstacles to break them. In these areas, the level of damage can rival that along the open coast.

Coastal flooding can also move inland into low-lying areas beyond the limit of wave action. The danger in these areas is primarily from inundation due to storm surge but, even here, fast-moving floodwaters can **scour** away the soil around building foundations.

Another cause of flooding, which can affect homes outside identified floodplains, is the limited capacity of local drainage systems, including storm sewers, culverts, and drainage ditches. These systems are usually designed to carry up to a specific amount of water, which is referred to as the “design capacity” of the system. When heavy rainfall over an area causes the design capacity of the system to be exceeded, water will begin to back up and fill low-lying areas near system inlets and along open ditches. Depending on the amount and **intensity of rainfall**, the floodwater may continue to rise and may eventually affect homes.



DEFINITION

A **flash flood** is a flood that rises and falls very quickly and usually is characterized by high flow velocities (see Section 2.4.2). Flash floods often result from intense rainfall over a small area, usually in areas of steep terrain.

Storm surge is the rise in the level of the ocean that results from the decrease in atmospheric pressure associated with hurricanes and other storms.

Wave action refers to the characteristics and effects of waves that move inland from an ocean, bay, or other large body of water. Large, fast-moving waves can cause extreme erosion and scour, and their impact on buildings can cause severe damage. During hurricanes and other high-wind events, storm surge and wind increase the destructiveness of waves and cause them to reach higher elevations and penetrate farther inland.

Erosion refers to a general lowering of the ground surface over a wide area.

Scour refers to a localized loss of soil, often around a foundation element.

Intensity of rainfall refers to the amount of rain that falls during a given amount of time. It is usually expressed in inches of rainfall per hour. The higher the number of inches per hour, the greater the intensity.

A similar problem occurs when drainage system inlets are plugged or obstructed by mud or other debris and when drainage system outlets are submerged by water during riverine or coastal floods. In the latter situation, water can flow backwards in the system and reach areas that otherwise might not have flooded.



Figure 2-4. This home in Wisconsin was inundated by riverine flooding.



Figure 2-5. The extreme impact of large, fast-moving waves, combined with the removal of supporting soil by erosion and scour, can have devastating effects on buildings exposed to coastal flooding. This home along the Gulf of Mexico shoreline was destroyed during Hurricane Opal.

2.4 How Flooding Can Damage Your Home

To understand how flooding can damage your home, you need to know about six important flood characteristics: depth/elevation, flow velocity, frequency, rates of rise and fall, duration, and debris impact. Most of these characteristics apply to both riverine and coastal flooding, and they can vary – sometimes greatly – from one place to another. The flood conditions at a particular site, such as the location of your home, are determined largely by the combination of these

characteristics. The following paragraphs explain these characteristics. Section 2.4 and Chapter 4 explain how you can determine the flood conditions at your home.

2.4.1 Depth/Elevation of Flooding

The depth and elevation of flooding are so closely related that, for the purposes of this discussion, they can be viewed as a single characteristic. **Flood depth** is the height of the floodwater above the surface of the ground or other feature at a specific point. **Flood elevation** is the height of the floodwater above an established reference **datum**. The standard datums used by most Federal agencies and many State and local agencies are the National Geodetic Vertical Datum (NGVD) and the North American Vertical Datum (NAVD); however, other datums are also in use. The use of other datums is important because elevations of the ground, floodwaters, and other features cannot be meaningfully compared with one another unless they are based on the same datum.

When the elevation of the ground (or another surface such as the **lowest floor** of your home) and the elevation of the floodwaters are both based on the same datum, the flood depth at any point is equal to the flood elevation at that point minus the elevation of the ground (or other surface) at that point. Figure 2-6 illustrates this relationship. One more thing you should know: ground elevations are established by surveys; flood elevations may be calculated or they may be known from water marks left by past floods.

The depth of flooding at your home is important primarily because floodwaters, even when they are not moving, exert pressure on structural components such as walls and concrete floor slabs. The pressure exerted by still water is called “hydrostatic pressure.” It is caused by the weight of the water, so it increases as the depth of the water increases. As shown in Figure 2-7, floodwater, including water that has saturated the soil under the home, pushes in on walls and up on floors. The upward force on floors is called “**buoyancy**.”



DEFINITION

An **elevation datum** is an arbitrary surface that serves as a common reference for the elevations of points above or below it. Elevations are expressed in terms of feet, meters, or other units of measure and are identified as negative or positive, depending on whether they are above or below the datum. Three common elevation datums are mean sea level (msl), NGVD, and NAVD.

Under the National Flood Insurance Program, the **lowest floor** of a building is the floor of the lowest enclosed area within the building, including the basement. The only exception is an enclosed area below an elevated building, but only when the enclosed area is used solely for parking, building access, or storage and is compliant with relevant regulations. The elevation of the lowest floor can be very important in retrofitting, as you will see in later chapters.

Buoyancy refers to the upward hydrostatic force that floodwater exerts on the floors of homes with enclosed spaces below the flood level.

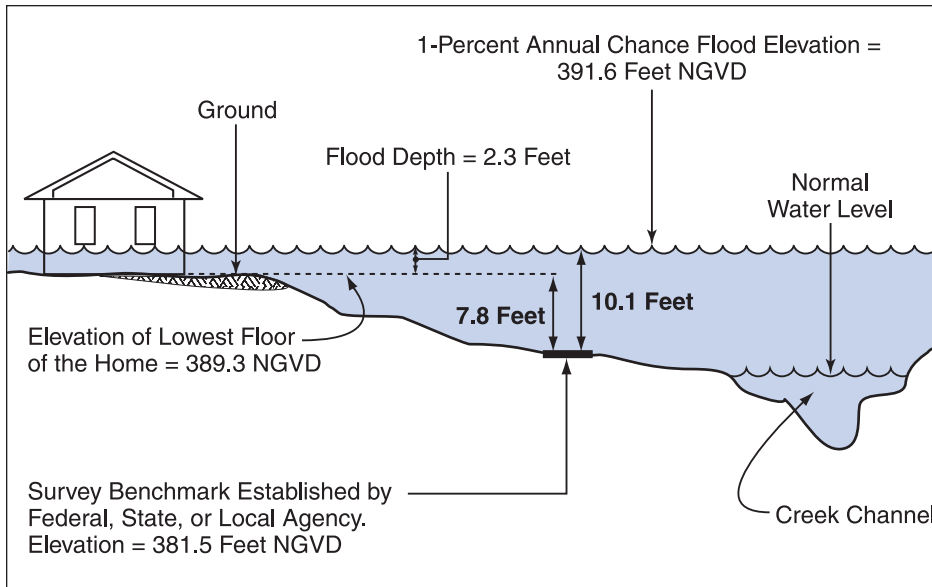

Figure 2-6. In this example, the 1-percent annual chance flood elevation is 391.6 feet (10.1 feet above the benchmark elevation of 381.5 feet), and the elevation of the lowest floor of the home is 389.3 feet (7.8 feet above the same benchmark). The flood depth above the lowest floor is therefore equal to 391.6 feet - 389.3 feet, or 2.3 feet during the 1-percent annual chance flood.

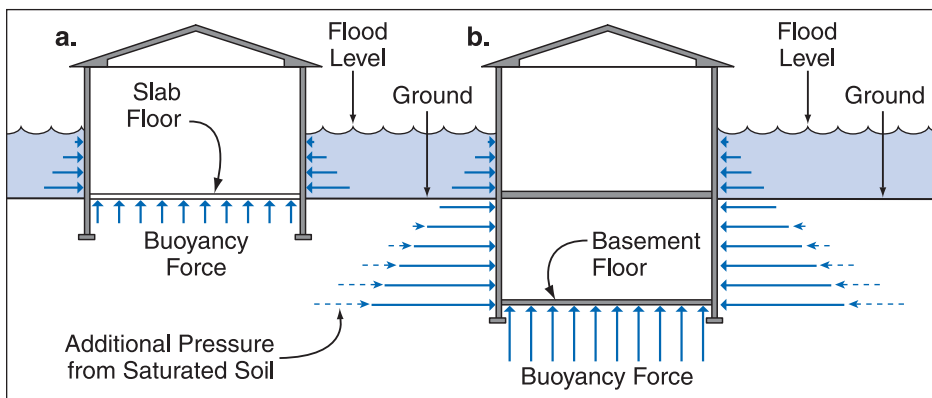

Figure 2-7. Hydrostatic pressure acts on walls and concrete slab floors. The weight of saturated soils adds to the pressure on basement walls. Figure 2-7a shows a home with a concrete slab floor. Figure 2-7b shows a home with a basement.

As shown in Figure 2-7b, water that has saturated the soil poses a special hazard for basement walls. Because hydrostatic pressure increases with the depth of the water, the pressure on basement walls is greater than the pressure on the walls of the upper floor, as indicated by the arrows in the figure. This pressure is made even greater by the weight of the saturated soil that surrounds the basement.

The walls of homes built using standard wood-frame or masonry construction are not designed to resist this pressure. If the pressure exceeds the strength of the walls (including basement walls), it can push them in or out (Figure 2-8), cause extensive structural damage, and possibly cause the home to collapse. In some areas, the buoyant force of hydrostatic pressure on basement floors has pushed homes entirely out of the ground.

If water is allowed to enter, the hydrostatic pressures on both sides of the walls and floor become the same, or “equalized” (Figure 2-9), and the walls are much less likely to fail. As discussed in Chapters 3, 5, and 6, this is an important consideration in some types of retrofitting methods.

Figure 2-8. The walls of this basement in Iowa failed because of the pressure exerted by water and saturated soil.



Figure 2-9. Once water enters the home, hydrostatic pressure is equalized. Figure 2-9a shows a home with a concrete slab floor. Figure 2-9b shows a home with a basement.

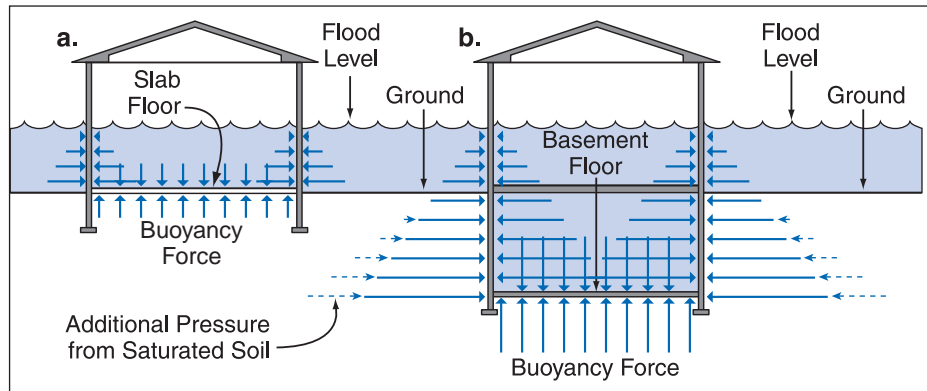

2.4.2 Flow Velocity

Flow velocity is the speed at which floodwaters move. It is usually measured in feet per second (fps). Flow velocities during riverine floods can easily reach 5 to 10 fps and, in some situations, may be even greater. Expressing velocities in fps is common in floodplain studies and engineering analyses. It may be helpful to relate fps to a more familiar unit of measure. For example, 10 fps is roughly equal to 7 miles per hour (mph).

The velocity of riverine floodwaters depends on a number of factors; one of the most important is the slope of the stream channel and floodplain. As you might expect, floodwaters will generally move much faster along streams in steep mountainous areas than streams in flatter areas. Even within the same floodplain, however, flow velocity can still vary. As water flows over the ground, its velocity depends largely on the roughness of the ground surface. For example, water will flow more swiftly over parking lots, roads, and other paved surfaces, and will flow more slowly over ground covered with large rocks, trees, dense vegetation, or other obstacles. Also, flow velocities in the floodplain will usually be higher nearer the stream channel than at the outermost fringes of the floodplain, where water may flow very slowly or not at all. In areas subject

to coastal flooding, velocities depend largely on the speed of the wind and, like riverine flow velocities, on the slope and roughness of the ground surface.

If your home is in an area where floodwaters are flowing, especially if they are moving more than about 5 fps, the flow velocity is important for several reasons. Flowing water pushes harder on the walls of a building than still water. So instead of just the hydrostatic pressure caused by the weight of the floodwater resting against the walls of your home, you have the additional pressure of moving water, referred to as “hydrodynamic pressure” (Figure 2-10). As water flows around your home, it pushes against the side of the home that faces the flow (the upstream side). As it flows past the sides of the home, it creates friction that can tear at wall coverings, such as siding. On the side of the home that faces away from the flow (the downstream side), the water creates a suction that pulls on walls.

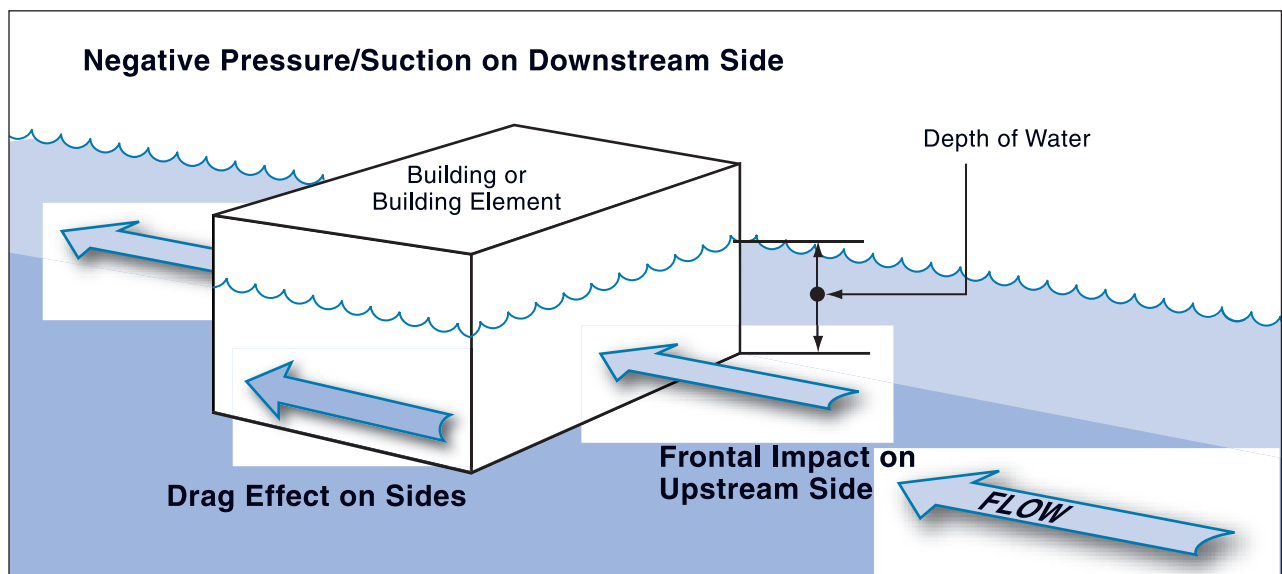

Figure 2-10. Moving water acts on the front, sides, and back of a home.

In some situations, the combination of these forces can destroy one or more walls (Figure 2-11), cause the home to shift on its foundation, or even sweep the home away.

Flowing water can also cause erosion and scour. As previously discussed, erosion refers to a general lowering of the ground surface over a wide area. Scour refers to a localized loss of soil, often around a foundation element. Both erosion and scour can weaken the structure of a home by removing supporting soil and undermining the foundation. In general, the extent and depth of erosion and scour increase as the flow velocity and size of the home increase. Also, keep in mind that any objects being carried by floodwaters will be moving at roughly the same speed as the water. The dangers associated with these objects are discussed in Section 2.4.6.

2.4.3 Flood Frequency

You may have been told that your home is in “the 100-year” floodplain, or you may have heard that term used to describe a specific flood. You may also have heard similar terms used, such as “50-year flood” or “500-year flood.” These terms can be misleading if not interpreted correctly. Flood frequencies are usually determined through statistics and engineering analyses performed by floodplain management agencies and other organizations responsible for implementation of flood control programs and floodplain regulation. The results of those analyses define the probability, expressed as a percentage, that a flood of a specific size on a specific stream will be equaled or exceeded in any year.

For example, the flood that has a 1-percent probability (1 in 100) of being equaled or exceeded in any year is sometimes referred to as the 100-year flood. This term is simply a convenient way to express probability. It should not be interpreted to mean a flood that happens exactly once every 100 years. Nor does it imply that, once a 100-year flood occurs, there is little risk of another 100-year flood occurring in the near future. To the contrary, changes in climatic conditions, such as those caused by El Niño, often result in “clusters” of floods that occur over relatively short times at the same location. In this publication, the term 1-percent annual chance flood is used to describe the 100-year flood.

For most homeowners, the value of these terms is that they indicate relative frequencies and sizes. Over time, a 1-percent annual chance (100-year) flood is expected to occur less often than a 2-percent annual chance (50-year) flood and more often than a 0.2-percent annual chance (500-year) flood. In addition, a 1-percent annual chance flood will be more severe than a 2-percent annual chance flood and less severe than a 0.2-percent annual chance flood. For example, if your home is in the 1-percent annual chance floodplain of a nearby stream or river, the 1-percent annual chance flood elevation at your home will be lower than the 0.2-percent annual chance flood elevation, and the water from a 2-percent annual chance flood might not even reach your home.

The 1-percent annual chance flood is particularly important for homeowners because it is the basis of NFIP flood insurance rates and regulatory floodplain management requirements. These requirements are discussed in detail in Section 2.6. In the NFIP, the 1-percent annual chance flood is referred to as the “base flood,” the 1-percent annual chance flood elevation as the



Figure 2-11. Moving water can cause walls to collapse, as illustrated by this riverine flood damage in Georgia.

“base flood elevation” (BFE), and the floodplain associated with the base flood as the Special Flood Hazard Area (SFHA). Other Federal agencies, such as the U.S. Army Corps of Engineers (USACE), use the 1-percent annual chance flood for planning and engineering design, as do many State and local agencies. These agencies often have their own names for the 1-percent annual chance flood.

2.4.4 Rates of Rise and Fall

You may not have heard these terms before, but they describe important characteristics of flooding: how rapidly the elevation (and therefore the depth) of water increases and decreases during a flood. These rates are usually expressed in terms of feet or inches per hour. Floodwaters with high flow velocities, such as those in areas of steep terrain, and water released by the failure of a dam or levee, usually rise and fall more rapidly than slower-moving floodwaters, such as those in more gently sloping floodplains.

Rate of rise is important because it affects how much warning you will have of an impending flood. For example, homeowners in the floodplains of large rivers like the Mississippi and Missouri may know days in advance that flooding is occurring upstream and will eventually reach their homes. But in the floodplains of streams with rapid rates of rise, homeowners may have only a few hours’ notice of a coming flood or perhaps none at all. With adequate warning, you will be better prepared to take steps to protect yourself and your property. Warning time is particularly important for flood protection methods that depend on action you must take. Chapters 3, 4, 6, and 7 further discuss this issue.

Rates of rise and fall are important also because of their effect on hydrostatic pressure. As explained in the discussion of flood depth/elevation, hydrostatic pressure is most dangerous for a home when the internal and external pressures are not equalized. This situation occurs when the level of water inside the home is significantly higher or lower than the level outside. When floodwaters rise rapidly, water may not be able to flow into a home quickly enough for the level inside the home to rise as rapidly as the level outside. Conversely, when floodwaters fall rapidly, water that has filled a home may not be able to flow out quickly enough, and the level inside will be higher than the level outside. In either situation, the unequalized hydrostatic pressures can cause serious structural damage, possibly to the extent that the home collapses.

2.4.5 Duration

Duration is how long a flood lasts. One of the meanings of duration is how long it takes for the creek, river, bay, or ocean to return to its normal level. As a homeowner, you may be more interested in how long floodwaters remain in or around your home or perhaps how long they block nearby streets. In many floodplains, duration is related to rates of rise and fall. Generally, water that rises and falls rapidly will recede more rapidly, and water that rises and falls slowly will recede more slowly. An example of this relationship is the extensive flooding that occurred in the broad, flat floodplains of the Midwest in 2008. In those areas, floodwaters rose slowly and remained high for many weeks or longer.

If your home is flooded, duration is important because it determines how long the structural members (such as the foundation, floor joists, and wall studs), interior finishes (such as dry-wall and paneling), service equipment (such as furnaces and hot water heaters), and building contents will be affected by floodwaters. Long periods of inundation are more likely to cause greater damage than short periods. Duration can also determine how long your home remains uninhabitable.

2.4.6 Debris Impact

Floodwaters can pick up and carry objects of all types – from small to large, from light to heavy – including trees, portions of flood-damaged buildings, automobiles, boats, storage tanks, mobile homes, and even entire homes. In cold climates, wintertime floods can also carry large pieces of ice. Dirt and other substances such as oil, gasoline, sewage, and various chemicals can also be carried by floodwaters. All of these types of debris add to the dangers of flooding. Even when flow velocity is relatively low, large objects carried by floodwaters can easily damage windows, doors, walls, and, more importantly, critical structural components of your home. As velocity increases, so does the danger of greater damage from debris. If floodwaters carrying large amounts of dirt or hazardous substances enter your home, damages may be greater. In addition, your cleanup costs are likely to be higher and your cleanup time greater.

As you read the remaining sections of this guide, keep these flood characteristics and their effects in mind. Section 2.4 and Chapter 4 explain how you can find out more about flooding in your area, including flood elevations near your home.

2.5 Other Hazards

Two more hazards you should be aware of are high winds (including hurricanes) and earthquakes. For homes in areas subject to these hazards, some retrofitting methods are more appropriate than others. Chapters 3, 4, and 5 further discuss this issue. But, regardless of the method you choose, if your home is in a high-wind or earthquake hazard area, your design professional or contractor must ensure that all structural changes made can withstand not only the expected flood forces, but the expected forces of winds or earthquakes as well.

Wind is similar to flowing water in that it pushes against the side of the home that faces the wind and pulls on the side that faces away (Figure 2-12). Wind passing over a home can exert a lifting force on the home. The combination of push, pull, and lift acts on the home, including the foundation, and can result in extensive damage if the structural system and **building envelope** are not adequately designed and constructed.

The ability of the wind to damage a building is increased if the wind or windborne debris breaches



DEFINITION

The **building envelope** is the entire exterior surface of a building (including walls, doors, and windows) that encloses or envelops the space within.

the building envelope by breaking windows, collapsing doors, or puncturing walls. Once the envelope is breached, wind will enter the building and the pressure on the walls and roof will increase, as shown in Figure 2-12. Wind and flood forces can combine in different ways, depending on the directions of the wind and flood flow. When the wind and flood flow direction are the same, the load on the home is greater than the load from either wind or flood alone.

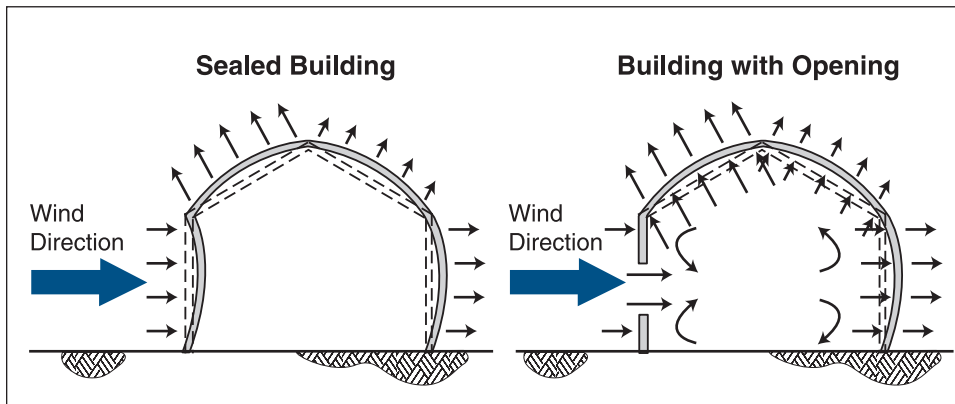

Figure 2-12. Wind forces on a sealed building and on a building with an opening.

The movement of the ground during an earthquake can place large horizontal and vertical loads on a home (Figure 2-13). Like the loads that result from flood flow and wind, earthquake loads can cause extensive damage to a home if they have not been accounted for in the structural design.

High-wind and earthquake hazards vary throughout the United States. In Chapter 4, you will find maps that show the areas where these hazards are greatest.

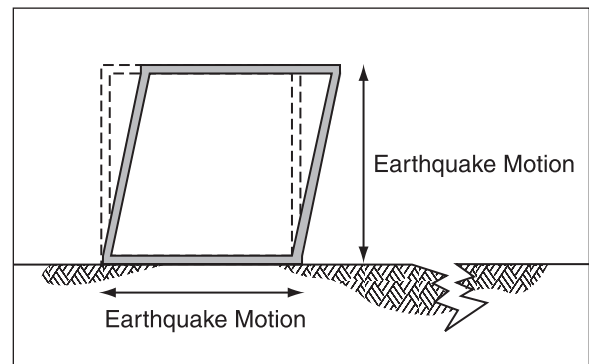

Figure 2-13. Earthquake forces act in both horizontal and vertical directions.

2.6 Federal, State, and Local Regulations

In most communities throughout the United States, construction in floodplains is governed by combinations of Federal, State, and local regulations. At the Federal level, FEMA administers the NFIP. Congress created the NFIP in 1968 when it passed the National Flood Insurance Act (NFIA). The NFIP is a voluntary program for communities. Its goal is to reduce the loss of life and the damage caused by flooding, to help the victims of floods, and to lower the costs of flood damage borne by the taxpayer. Communities participate in the NFIP by:

- guiding future development away from flood hazard areas,
- requiring that new buildings, **substantially improved** existing buildings, and repair of **substantially damaged** existing buildings in the SFHA be constructed in compliance with floodplain management ordinances and laws intended to reduce flood damage,

- providing floodplain residents with financial assistance after floods, and
- transferring the cost of flood losses from the taxpayer to the owners of flood-prone buildings by requiring the purchase of flood insurance for buildings in the SFHA.

The NFIP operates through a partnership between the Federal Government, the States, and individual communities such as counties and incorporated cities, towns, and villages.

A participating community adopts and enforces a floodplain management ordinance or law to regulate development within that floodplain, including new construction, substantial improvement of existing buildings, and repair of substantially damaged buildings. In return, federally-backed flood insurance is made available to property owners and renters through the community.

A participating community's floodplain management ordinance or law must, at a minimum, meet the requirements of the NFIP regulations, but each community is free to establish additional or more stringent requirements to provide additional protection. For example, the regulatory floodplain defined by a community must include the entire SFHA, but it may also include other flood hazard areas within the community. Additionally, some States require communities to adopt and enforce floodplain management requirements that exceed the minimum requirements of the NFIP.

These points are particularly important because of their potential effect on your retrofitting project. In this guide, you will find many references to requirements included within your community's floodplain management ordinance or law. These are the minimum requirements that all communities must adopt and enforce in their floodplain management ordinances or laws to be compliant with the NFIP regulations. Remember that you must comply with your community's requirements, which may be more stringent.

Usually, communities enforce other requirements that affect construction, both inside and outside of the regulatory floodplain. These requirements include those associated with building codes and land use regulations, such as zoning and subdivision ordinances.



DEFINITION

Under the NFIP, an improvement of a building (such as reconstruction, rehabilitation, or an addition) is considered a **substantial improvement** if its cost equals or exceeds 50 percent of the market value of the building before the start of construction of the improvement.

Similarly, damage to a building, regardless of the cause, is considered **substantial damage** if the cost of restoring the building to its before-damage condition would equal or exceed 50 percent of the structure before the damage occurred. Consult your local officials about determining the value of your home.

For more information, consult your local officials or refer to FEMA 213, *Answers to Questions About Substantially Damaged Buildings*.

2.6.1 The Community Rating System

The NFIP Community Rating System (CRS) is a voluntary incentive program that recognizes and encourages community floodplain management activities that exceed the minimum NFIP requirements. The three goals of the CRS are to:

1. Reduce flood losses
2. Facilitate accurate insurance rating
3. Promote awareness of flood insurance

When communities participate in the CRS, flood insurance rates for insured property owners and renters are discounted in increments of 5 percent to a maximum discount of 45 percent, based on 18 creditable activities. The activities are organized under four categories:

1. Public information (e.g., offering references on flood insurance and flood protection at the public library)
2. Mapping and regulations (e.g., guaranteeing that a portion of currently vacant floodplain will be kept free from development)
3. Flood damage reduction (e.g., acquiring, elevating, and/or relocating flood-prone buildings so that they are out of the floodplain)
4. Flood preparedness (e.g., providing early flood warnings to the public)

To apply for CRS participation, a community submits documentation of its floodplain management activities to the Insurance Services Office, which works on behalf of FEMA and the insurance companies. Specific information about CRS and the application process can be found at the CRS online resource center at <http://training.fema.gov/EMIWeb/CRS/>.

2.6.2 Flood Insurance Rate Maps

To provide communities with the information they need to enact and enforce floodplain management ordinances or laws, FEMA conducts floodplain studies for communities throughout the United States and publishes the results in Flood Insurance Studies (FISs) and Flood Insurance Rate Maps (FIRMs) (Figure 2-14). Digital Flood Insurance Rate Maps (DFIRMs) are also available in many communities. The FIS and FIRM for your community provide information about the names and locations of flooding sources, sizes and frequencies of past floods, limits of the SFHA and **floodway**, flood flow velocities, and elevations of the base flood in the SFHA. With this information, communities can manage floodplain development and FEMA can establish flood insurance rates.



DEFINITION

The **floodway** is the portion of the SFHA that must be kept free of new development so that flood elevations will not increase. The floodway usually consists of the stream channel and land along either side. The flood hazard is usually greater in the floodway than in the surrounding areas of the SFHA, referred to as the “flood fringe.”

The NFIP regulations do not prohibit development in the SFHA. Instead, they require that residential buildings in the SFHA be elevated to or above the BFE. But floodplain development can reduce the amount of space available to convey floodwaters and increase flood elevations. So this development must be controlled. The **floodway** is the regulatory means of providing the required control.

Figure 2-14. This portion of a FIRM shows the SFHA (dark tint), 0.2-percent annual chance floodplain (light tint), floodway (hash-marked area between the dashed lines), BFEs (numbered wavy lines and/or numbers in parentheses), and the insurance rate zones (AE and A= SFHA, VE = Coastal High Hazard Area, and X = area outside SFHA).

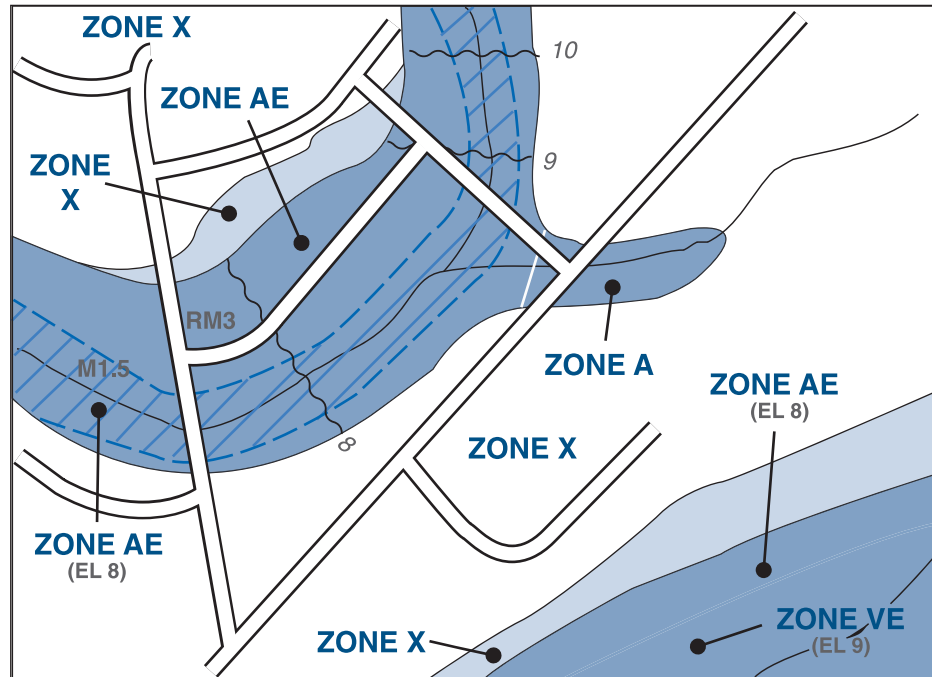

FIRMs are available online at FEMA’s Map Service Center (MSC), <http://msc.fema.gov>. The site allows you to search for your flood map in one of four ways, by:

- Searching for your address
- Using the catalog, which allows you to select your State, County, community, and flood map from a list
- Using a map search, which allows you to zoom into your community from a map of the United States
- By searching for a map panel by ID number

Once you find your FIRM, you can create a printable FIRMette using the MSC Viewer. A FIRMette is a full-scale section of a FEMA FIRM that you create for yourself online. There is no cost for making a FIRMette. FIRMettes are used by many different parties such as community officials, mortgage lenders, real estate agents, design professionals, insurers, land developers, engineers, and surveyors.

The MSC Viewer allows you to zoom to the area you want to be included in your FIRMette and format your printable map. You can save your FIRMette either as an Adobe PDF or as a Tiff Image File. The Map Service Center offers a step-by-step tutorial on creating FIRMettes.

Other Federal agencies, such as the U.S. Army Corps of Engineers, U.S. Geological Survey (USGS), and Natural Resources Conservation Service (NRCS, formerly the U.S. Soil Conservation Service), also publish flood information, as do some State and local agencies. This information is often useful as a supplement to FISs and FIRMs but, because it is developed to meet other needs, it is not used for the NFIP unless it has been reviewed and approved by FEMA.

If you have questions about flood hazards in your community, including the limits of the regulatory floodplain, flood elevations, or sizes and frequencies of past floods, check with your local officials. Usually, they will have copies of the FIS and FIRM for your community. They can also help you determine whether your home is in the regulatory floodplain and advise you about flood protection methods, including those described in this guide. Local officials can also advise you about floodplain management requirements, building codes, and other requirements that may determine the types of changes you can make to your home. See Chapter 4 for more information about working with local officials. You can also get help from your FEMA Regional Office (Appendix C) and the office of your State NFIP Coordinator (Appendix D).

2.7 Financial Assistance for Retrofitting

2.7.1 Federal Programs

FEMA and other Federal agencies have an array of financial assistance programs that assist States, communities, and individual property owners mitigate the negative effects of flood hazards. You may be eligible to receive financial assistance through one or more of these programs that will help pay for some of the retrofitting projects documented in this guide. Check with your local officials, the FEMA Regional Office for your State (Appendix C), your NFIP State Coordinator (Appendix D), or your State Hazard Mitigation Office (SHMO, Appendix E).

If a Presidential Declaration of a Major Disaster has been issued for your area, you may want to seek information from FEMA and the State and local government representatives supporting the post-disaster recovery of your community. Keep in mind, however, that the funding for these programs is limited and that often not everyone's needs can be met. Many Federal assistance programs provide grants to State and local governments, who must then set priorities for the use of the grant funds, including any potential use by individual property owners.

Help from FEMA

Increased Cost of Compliance

One of the benefits provided by the NFIP is Increased Cost of Compliance (ICC) coverage. If your home is covered by a Standard Flood Insurance Policy (SFIP), is in an SFHA, and has been declared by your community to be substantially damaged or repetitively damaged by flood, ICC will help pay for certain types of retrofitting. ICC coverage is available on most SFIPs.

If your home sustains a flood loss and the community has declared it substantially damaged or repetitively damaged, ICC will help pay the cost (up to \$30,000 effective May 1, 2003), for the following retrofitting methods:

- Elevating your home so that its lowest floor is at or above the BFE (see Chapters 3 and 5).
- Moving your home to another floodplain location on your lot and elevating it if this is the only location or moving your home out of the regulatory floodplain completely (see Chapters 3 and 7).
- Demolishing your damaged home (see Chapters 3 and 7).

As noted earlier, your community's floodplain management ordinance or law must include a requirement for substantial damage. Substantial damage is defined in Section 2.6.

Some communities may have adopted a repetitive loss provision so that repetitively damaged buildings can qualify for an ICC claim payment. In order for buildings to qualify for a claim payment under ICC coverage as a "repetitive loss structure," the building must be covered by a contract for flood insurance and incur flood-related damages on two occasions during a 10-year period ending on the date of the event for which the second claim is made, in which the costs of repairing the flood damage, on the average, equaled or exceeded 25 percent of the market value of the building at the time of each such event. Note that ICC availability under this provision applies only if the community has adopted a repetitive loss provision in the floodplain management ordinance or law. Also, note that, under the NFIP communities are not required to adopt a repetitive loss provision in their floodplain management ordinance or law.



NOTE

This section is not meant to be an all-inclusive description of Federal assistance. Following a Presidentially Declared Major Disaster, State and local officials will be briefed on the available types of post-disaster assistance.



NOTE

If a flood in your area is a federally-declared disaster, you must register with FEMA to obtain assistance. The directions at <http://www.fema.gov> will walk you through the application process.

Remember, communities with a more restrictive floodplain management ordinance or law may require a greater level of protection. If, for example, your community requires new and substantially improved or substantially damaged buildings to be elevated 1 or more feet above the BFE, ICC allows for an ICC claim payment up to the \$30,000 limit of coverage.

An ICC claim may also be paid for a combination of retrofitting actions. For example, ICC coverage allows for a claim payment for the cost of demolition and elevation at the same or another site within the SFHA. The ICC payment to demolish and elevate your home is limited to \$30,000.

To learn more about ICC coverage, review your SFIP and contact your insurance agent, your community floodplain management official, the FEMA Regional Office that serves your community (Appendix C), or the office of your NFIP State Coordinator (Appendix D). If a Presidential Declaration of a Major Disaster has been issued for your area, you can get help from the Mitigation and Insurance Desk at the local Disaster Recovery Centers.

Unified Hazard Mitigation Assistance Program

FEMA's Hazard Mitigation Assistance (HMA) grant programs present a critical opportunity to protect individuals and property from natural hazards while simultaneously reducing reliance on Federal disaster funds. The HMA programs provide pre-disaster mitigation grants annually to States, Territories, Tribes, and local communities. The statutory origins of the programs differ, but all share the common goal of reducing the loss of life and property due to natural hazards.

Applications for each program are submitted by State emergency management agencies on behalf of several subapplicants. Eligible subapplicants generally include State agencies, local governments, public colleges and universities, and others. Subapplications submitted by State agencies and local governments consist of projects for individual properties.

Five grant programs are currently included in the Unified HMA program:

The Hazard Mitigation Grant Program (HMGP) is authorized by Section 404 of the Robert T. Stafford Disaster Relief and Emergency Assistance Act, as amended (the Stafford Act), Title 42, United States Code (U.S.C.) 5170c. The key purpose of HMGP is to ensure that the opportunity to take critical mitigation measures to reduce the risk of loss of life and property from future disasters is not lost during the reconstruction process following a disaster. HMGP is



DEFINITION

The NFIP regulations define a **basement** as “any area of the building having its floor subgrade on all sides.” Note that the NFIP definition of basement does not include what is typically referred to as a “walkout-on-grade” basement, whose floor would be at or above the surface of the ground that touches the outside walls of the building on at least one side (see page 3-3). This ground surface is referred to as the “adjacent grade.”

available, when authorized under a Presidential major disaster declaration, in the areas of the State requested by the Governor. The amount of HMGP funding available to the Applicant is based upon the estimated total Federal assistance to be provided by FEMA for disaster recovery under the Presidential major disaster declaration.

The Pre-Disaster Mitigation (PDM) program is authorized by Section 203 of the Stafford Act, 42 U.S.C. 5133. The PDM program is designed to assist States, Territories, Indian Tribal governments, and local communities to implement a sustained pre-disaster natural hazard mitigation program to reduce overall risk to the population and structures from future hazard events, while also reducing reliance on Federal funding from future disasters.

The Flood Mitigation Assistance (FMA) program is authorized by Section 1366 of the National Flood Insurance Act of 1968, as amended (NFIA), 42 U.S.C. 4104c, with the goal of reducing or eliminating claims under the National Flood Insurance Program (NFIP).

The Repetitive Flood Claims (RFC) program is authorized by Section 1323 of the NFIA, 42 U.S.C. 4030 with the goal of reducing flood damages to individual properties for which one or more claim payments for losses have been made under flood insurance coverage and that will result in the greatest savings to the National Flood Insurance Fund (NFIF) in the shortest period of time.

The Severe Repetitive Loss (SRL) program is authorized by Section 1361A of the NFIA, 42 U.S.C. 4102a, with the goal of reducing flood damages to residential properties that have experienced severe repetitive losses under flood insurance coverage and that will result in the greatest savings to the NFIF in the shortest period of time.

The NFIP provides the funding for FMA, RFC, and SRL programs. The PDM, FMA, RFC, and SRL programs are subject to the availability of appropriation funding, as well as any program-specific directive or restriction made with respect to such funds. Furthermore, availability of the PDM and SRL programs is subject to anticipated reauthorization of the programs beyond September 30, 2009.

Table 2-1 provides a summary of eligible retrofit activities for each of the five programs in the Unified HMA program. More information about each program can be found on the FEMA HMA web site at <http://www.fema.gov/government/grant/hma/index.shtm>.

Table 2-1. Eligible Retrofit Activities by Program

Eligible Activities	HMGP	PDM	FMA	RFC	SRL
Acquisition/Demolition (for purposes of open space)	✓	✓	✓	✓	✓
Relocation	✓	✓	✓	✓	✓
Elevation	✓	✓	✓	✓	✓
Dry Floodproofing (historic residential structures)	✓	✓	✓	✓	✓
Mitigation Reconstruction					✓

Help from Other Federal Agencies

Several Federal agencies offer disaster assistance to communities and citizens. For a complete list of Federal assistance programs for which you may be eligible, visit <http://www.disasterassistance.gov>.

Small Business Administration (SBA)

SBA provides low interest disaster loans to homeowners, renters, businesses of all sizes, and private, non-profit organizations to repair or replace real estate, personal property, machinery and equipment, and inventory and business assets that have been damaged or destroyed in a declared disaster. Visit <http://www.sba.gov/services/disasterassistance/> for more information.

U.S. Department of Housing and Urban Development (HUD)

HUD provides flexible grants to help Cities, Counties, and States recover from Presidentially Declared Disasters, especially in low-income areas, subject to availability of supplemental appropriations. Visit <http://www.hud.gov/> for more information.

U.S. Army Corps of Engineers (USACE)

The USACE has the statutory authority to participate in flood protection projects that may include residential retrofitting (including elevating flood-prone homes and acquiring badly damaged flood-prone homes). Contact the appropriate USACE Division office for further information. You can find more information and contact information for your USACE Division office at <http://www.usace.army.mil>.

Natural Resources Conservation Service (NRCS), U.S. Department of Agriculture (USDA)

The NRCS has the statutory authority to participate in small watershed flood protection projects that may include residential retrofitting. Contact your local Conservationist for further information. More information is available at <http://www.nrcs.usda.gov>.

Other Assistance Programs

Other Federal programs intended to protect and improve the environmental quality of floodplains may offer financial assistance.

2.7.2 Non-Federal Help

Programs Sponsored by State and Local Governments

States, local governments, and flood control and drainage districts sometimes develop financial assistance programs to promote flood hazard retrofitting projects. Ask your local officials whether such a program exists in your community.

Voluntary Organizations

After floods and other major disasters, voluntary organizations often offer their services to support the rebuilding of homes. Occasionally, materials are donated and volunteers offer to provide labor that could be used to reduce the cost of a retrofitting project. Check with local officials, local service organizations, and homes of worship for information about such services. Note that you must obtain building permits and comply with all relevant regulations (including substantial damage requirements, if they apply), even if you receive assistance from voluntary organizations.

Environmental Interest Organizations, Including Land Trusts and Nature Conservancies

Numerous non-government, non-profit, and quasi-public organizations are dedicated to enhancing the environmental benefits of floodplains. Sometimes these organizations provide funds that can be used in the restoration or protection of the natural beneficial value of the floodplain.

3.0 An Overview of the Retrofitting Methods

3.1 Introduction

This guide describes six retrofitting methods for you to consider as you think about how to protect your home from flooding:

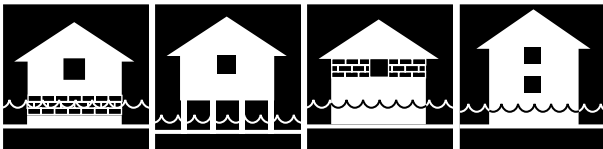

ELEVATION – Raising your home so that the lowest floor is above the flood level. You can accomplish this in several ways.



WET FLOODPROOFING – Making uninhabited portions of your home resistant to flood damage and allowing water to enter during flooding.



RELOCATION – Moving your home out of the floodplain to higher ground where it will not be exposed to flooding.



DRY FLOODPROOFING – Sealing your home to prevent floodwaters from entering.



LEVEES AND FLOODWALLS – Building a floodwall or levee around your home to hold back floodwaters.



DEMOLITION – Tearing down your damaged home and either rebuilding on the same property or buying or building a home elsewhere.

This chapter describes the six methods in detail. Keep in mind that only elevation, relocation, and demolition can be used to meet the minimum requirements of the NFIP. The other methods may be used to minimize damages, but are not recognized as meeting the minimum requirements of the NFIP. Remember that it is important to purchase flood insurance for your home, even if you mitigate your home using one of these methods.

For each method, you will find a section that explains how the method works and where it should and should not be used, lists its advantages and disadvantages, and provides a cost estimate. But first, you should be aware of some general cautions about retrofitting.



WARNING

In the areas listed below, the risks to lives and property are usually greater than in other flood-prone areas:

- Coastal High Hazard Areas (insurance Zones V, VE, and V1-V30) shown on a FIRM (Figure 2-14)
- Special Flood Hazard Areas seaward of the limit of moderate wave action (LiMWA), also called Coastal A Zones
- floodways shown on a FIRM (see Figure 2-14)
- alluvial fan flood hazard areas (certain Zone AO with depths and velocities) shown on a FIRM
- areas subject to flash floods
- areas subject to ice flows
- areas subject to extremely high-velocity flood flows

Modifying a home to protect it from flood damage in these areas requires extreme care and may also require complex, engineered designs. If your home is in one of these areas, you should consider relocation or demolition (as described later in this chapter and in Chapter 7) rather than any of the other retrofitting methods discussed in this guide. If you have any doubt about whether your home is in an area of unusually severe hazard, consult your local officials.

3.2 Cautions

3.2.1 Substantial Improvement/Substantial Damage

As noted in Chapter 2, your community’s floodplain management ordinance or law includes restrictions on the types of changes that may be made to a home that is being **substantially improved** or that has sustained **substantial damage**. These restrictions prohibit or limit the use of some retrofitting measures. Two of the six methods described in this guide – dry floodproofing and levees/floodwalls – can reduce future damage but may not be used to bring a substantially improved or substantially damaged home into compliance with your community’s



NOTE

Substantial improvement and substantial damage are defined in Section 2.6 and Appendix B.

floodplain management ordinance or law. Instead, in accordance with your community's requirements, you must do one of the following:

- Move the home out of the regulatory floodplain
- Elevate the home so that its lowest floor is at or above the BFE
- In conjunction with elevation, wet floodproof the areas of the home below the BFE and use them only for parking, building access, or storage
- Demolish the home and either rebuild or buy a home elsewhere

Additional requirements apply to the use of wet floodproofing. These are described later in this chapter and in Chapter 6.

3.2.2 Basements

Another important floodplain management requirement concerns basements. If your home has a basement below the BFE and your local officials determine that it is being substantially improved or is substantially damaged, the basement must be eliminated. You can usually do this by backfilling it with compacted soil. For floodplain management purposes, the NFIP regulations define a basement as “any area of the building having its floor subgrade on all sides.” Your community's floodplain management ordinance or law may include a more restrictive definition of basement.

Note that the NFIP definition of “basement” does not include what is typically referred to as a “**walkout-on-grade**” basement, whose floor would be at or above adjacent grade on at least one side of the building. Depending on your community's floodplain management ordinance or law, the requirement to eliminate the basement in a substantially improved or substantially damaged home may not apply to a walkout-on-grade



DEFINITION

Walkout-on-grade is a term commonly used to describe a basement whose floor is at ground level on at least one side of a home. The term “walkout” is used because most basements of this type have an outside door or doors (entry door, garage door, or both) at ground level (see figure below). Note that, if a basement floor is below grade on all sides (a basement as defined by the NFIP regulations), the basement may still have an outside door, but the door will be below ground level and stairs will be required for access.

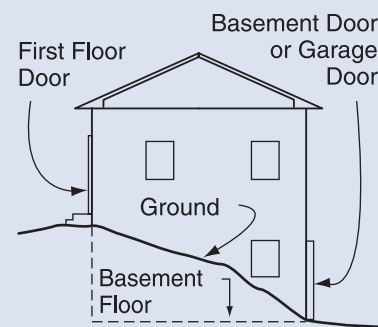

**Walkout-on-Grade
Basement**

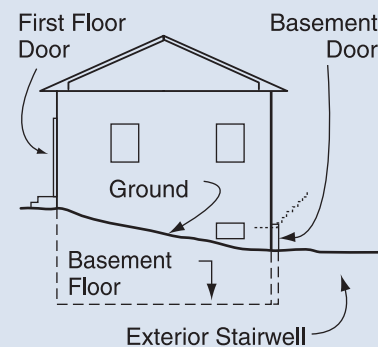

Subgrade Basement

basement. Instead, you may be able to wet floodproof the area. However, a wet floodproofed walkout-on-grade basement may be used only for parking, building access, or storage.

Your local officials can tell you more about these requirements and others that may be specified by local building codes and ordinances (see Chapter 4).

3.2.3 Design Flood Elevation and Risk

When you retrofit your home, one of the most important things you will do is choose a level of flood protection. In other words, will you protect your home from the base flood, the 0.2-percent annual chance flood, or some other flood? In some instances, this decision will be entirely yours; in others, it will depend largely on the regulatory requirements of your community, your State, or both. If your retrofit project is being funded through a Federal, State, or local agency, you may also be subject to different regulatory requirements.

As you will see in this chapter, different retrofitting methods protect your home in different ways. For example, when you elevate your home, you protect it by raising its lowest floor to a specified elevation. In wet floodproofing and dry floodproofing, you use flood damage-resistant materials, sealants, and shields to protect the part of your home below the BFE or other specified elevation. When you protect your home with a levee or floodwall, the top of the levee or floodwall is constructed to a specified elevation. In each of these examples, the specified elevation is referred to as the “**design flood elevation**” (DFE). Your protection is either greatly diminished or eliminated once floodwaters reach the DFE.



DEFINITION

For the purposes of this document, **design flood elevation (DFE)** is used to mean the retrofit elevation for your project. In other FEMA publications, and for certain mitigation grant programs, the term DFE may be more narrowly defined and may be associated with certain regulatory requirements.

If your home is being substantially improved or has been substantially damaged, your community’s floodplain management ordinance or law will specify a DFE that is at least equal to the BFE (the elevation of the 1-percent annual chance flood). Communities may require a higher DFE if they wish, or they may be required to do so by State law. Some States and communities require a higher DFE by establishing freeboard requirements, as discussed in Section 3.2.4. Your local officials can advise you about this.

Although you cannot use a DFE lower than that required by your community, you are probably free to use a higher DFE if you wish to provide a greater level of flood protection. Depending on your situation, your choice of flood protection method and DFE will be based largely on cost and risk of your home to flood damages.

In general, you will find that the cost of retrofitting increases as your DFE increases. For example, protecting your home to the elevation of the 2-percent annual chance flood with one of the methods described in this guide will probably cost you less than protecting it to the BFE with the same method (although the additional cost to protect to the BFE may be small). Although using a lower DFE may result in a less expensive retrofitting project, it exposes your home to a greater risk of flood damage and higher insurance rates. So in choosing a DFE, you must consider not only how much you are willing to pay, but also the level of risk you are willing to accept, including the potential for damage, financial loss, and emotional distress. For example, recent studies have shown that adding 1 to 3 feet of freeboard above the BFE to an elevation project can pay for itself within a few years through a 25 to 60 percent reduction in flood insurance premiums.

Event	Probability that Event will be Equaled or Exceeded in a 30-year Period
10-year (10% annual chance)	96%
25-year (4% annual chance)	71%
50-year (2% annual chance)	45%
100-year (1% annual chance)	26%
500-year (0.2% annual chance)	6%

One way to see the relationship between DFE and risk is to look at the probabilities associated with floods of various magnitudes during a period of 30 years, the length of a standard mortgage (see table above). The percentages shown along the vertical scale of the graph are the probabilities that a flood will be equaled or exceeded during a 30-year period. As you can see, this probability decreases as the magnitude of the flood increases. So the probability of a flood with an elevation equal to or greater than the DFE you choose decreases as your DFE increases. For example, compare the risks associated with the 2-percent annual chance (50-year) flood and the base flood. If you choose a DFE equal to the elevation of the 2-percent annual chance 50-year flood, the probability that a flood as high as or higher than your DFE will occur during a 30-year period is 45 percent. But if you choose a DFE equal to the BFE, the probability drops to 26 percent.

Regardless of the DFE you choose or are required to use, you must realize that a larger flood is always possible and that there will always be some risk of damage. If you don't have flood insurance, you should purchase a policy; if you have flood insurance, you should maintain your policy, even if you have protected your home to or above the BFE. Once a home has been retrofitted to meet the NFIP requirements for substantially improved structures, it will probably be eligible for a lower flood insurance rate.

3.2.4 Freeboard

Freeboard is an additional amount of height included in the DFE to provide a factor of safety. If you are protecting your home by elevating it, dry floodproofing it, or building a levee or flood-wall, you should include a minimum of 1 foot of freeboard in your DFE, even if your community does not require you to do so. For example, if you are elevating your home to protect it from the base flood, your DFE should be equal to the BFE plus 1 foot.

Freeboard is recommended because of uncertainties regarding expected flood elevations. These uncertainties exist for several reasons, but the two primary reasons are limitations of the analytical methods used in floodplain studies and potential effects of future **watershed** development, such as the construction of buildings and roads.

FEMA and other agencies that perform floodplain studies use a variety of standard engineering methodologies to determine flood frequencies and flood elevations. These methods involve the use of historical data, field measurements, and assumptions and judgments, all of which can affect the accuracy of the results. Some amount of uncertainty regarding the results is therefore unavoidable, and the potential for flood elevations higher than those expected should always be accounted for in retrofitting. For example, FEMA's Flood Insurance Rate Maps (FIRMs) include areas subject to the 0.2-percent annual chance flood (designated on FIRMs as B zones or Shaded X zones) and areas outside of the 0.2 percent annual chance flood (designated on FIRMs as C zones or Unshaded X zones). Homes constructed in B, C, or X zones are not considered to have a high risk of flooding by the NFIP, but that does not mean that they are not subject to flooding. In fact, 25 to 30 percent of all flood insurance claims are for flood damages that occur in one of these zones.

Another example of uncertainties in mapping exists in coastal areas. Coastal FIRMs show Coastal High Hazard Areas (designated on FIRMs as Zones V, VE, and VI-V30) that are subject to waves of 3 feet or higher. However, historic observations have shown that many coastal homes located outside of V zones still experience significant damage from moderate wave heights of 1.5 to 3 feet. For this reason, FEMA is working to update many coastal FIRMs to include SFHAs seaward of the LiMWA, also known as Coastal A zones. While this is not an NFIP requirement, FEMA recommends that homes located in Coastal A zones meet the same requirements as homes constructed in V zones.

Development in a watershed can increase the size and frequency of floods in that watershed. In general, watershed development reduces the amount of open ground available to absorb water from rain and melting snow and, therefore, increases the amount of water that makes its way into streams. As a result, in a developing watershed, an amount of rainfall that might have caused minor floods in the past may cause larger floods and higher elevations in the future.

FEMA's floodplain studies are based on the watershed conditions existing at the time the studies are performed. They do not account for potential increases in watershed development or any other changes that might affect the sizes of future floods. The reason for this approach is that one of the primary purposes of FISs and FIRMs is to provide the technical basis for establishing flood insurance rates. Therefore, the flood hazards must be shown as they are, not as they might be. Also, attempting to predict the level of future watershed development in every study and determine the effects not only would be extremely difficult, but also would require



DEFINITION

The **watershed** of a stream is the geographic area that contributes surface water, from rain or melting snow, to that stream.

additional assumptions and judgments that could increase uncertainty. In many watersheds, however, some amount of development is inevitable. So, providing freeboard is a prudent means of protecting against the increased flood elevations that may result.

3.2.5 Human Intervention

Retrofitting methods fall into two general categories: those that depend on **human intervention**, which are referred to as “active” methods, and those that do not, which are referred to as “passive” methods. For example, elevating your home does not require human intervention to be effective. But what if you have a floodwall with an opening for your car? In addition to requiring interior drainage, a floodwall with an opening will protect your home only if you can close the opening before flooding occurs. So your floodwall will have to be fitted with a gate (or some other type of closure mechanism) and, every time flooding threatens, you will have to be warned far enough in advance so that you can close the gate in time.

The need for adequate warning time and human intervention makes active methods less reliable than passive methods. You should try to avoid active methods when you choose a retrofitting method for your home, keeping in mind that active methods cannot be used to bring a home into compliance with the NFIP. If your retrofitting project includes active methods, you must have a plan that describes what actions you will take to make the measures work and when you will take those actions.

3.2.6 Other Considerations

Retrofitting may be the best means of protection for a homeowner whose home is in an area where a large flood control project, such as a dam, levee, or major waterway improvement, is not feasible, warranted, or appropriate. But you should keep the following in mind whenever you consider a retrofitting project:

- Communities participating in the NFIP require permits for all development within the regulatory floodplain. Under your community’s floodplain ordinance or law, any changes to buildings and other structures are considered “development.” These changes include improvements and repairs of existing buildings and other structures. Also, communities usually require building permits for many of the activities associated with the retrofitting methods described in this guide. In communities that have adopted a floodplain ordinance



DEFINITION

Human intervention is any action that a person must take to enable a flood protection measure to function as intended. This action must be taken every time flooding threatens.



WARNING

Some communities may restrict or prohibit the use of active retrofitting methods for flood protection.

or law, health code, and building code, the permits required by these ordinances, laws, and codes may be issued separately or as one combined permit. You may need a permit for the following:

1. Modifying your existing home or building a new home on a flood-prone site. A floodplain permit and possibly a building permit will be required.
2. Moving a home on public rights-of-way. If you relocate your home, you will probably need a permit, not only from your community but also from your State as well as from any other communities through which the home will pass on its way to the new site. A relocation project may also require a permit for the foundation at the new site.
3. Demolishing a damaged home and restoring the site after demolition, including grading, planting vegetative cover, capping and abandoning utilities, and removing or securing underground septic and fuel storage tanks.

You may wish to obtain the permits necessary for your retrofitting project yourself or arrange for your retrofitting contractor or design professional to obtain them. But remember, you must have the necessary permits in hand before you begin your project. As discussed in Chapter 4, your local officials are the best source of information about State and local permit requirements.

- In addition to meeting the requirements of the floodplain management ordinance and building codes, you may need to comply with the requirements of other Federal, State, and local laws and ordinances, such as those dealing with zoning setbacks and wetlands. Again, your local officials are the best source of information about these requirements.
- If your retrofitting project will involve financial assistance from a Federal agency and your property is 50 years old or older, you must work with that agency to ensure that your project complies with the National Historic Preservation Act (16 U.S.C. 470). The act requires that, before releasing any Federal assistance, the agency determine whether the property is eligible for inclusion in the National Register of Historic Places and, if so, whether your project will have any effect on the historic character of the property. This requirement may not apply in some emergency situations or if the agency has made prior arrangements with historic preservation officials. For more information, contact your State Historic Preservation Office (Appendix E).



NOTE

Your design professional or contractor should review some or all of the following nationally recognized codes and standards:

- International Code Council, 2009 *International Building Code*® (IBC® 2009)
- International Code Council, 2009 *International Existing Building Code*® (IEBC® 2009)
- International Code Council, 2009 *International Residential Code*® (IRC® 2009)
- American Society of Civil Engineers, *Minimum Design Loads for Buildings and Other Structures* (ASCE 7-05)
- American Society of Civil Engineers, *Flood Resistant Design and Construction* (ASCE 24-05)

See Appendix A for more information.

- Most retrofitting measures should be designed and constructed by experienced professionals such as contractors, engineers, and architects. Using professionals helps you make sure that the work is done properly, that code and regulatory requirements are met, and that, once completed, the retrofitting measures will work.
- Most retrofitting measures cannot be simply installed and forgotten. You will need to periodically inspect and maintain them to be sure that they will continue to work over time, especially if they require human intervention or depend on certain materials.
- Even though retrofitting will help protect your home from flooding, you should never remain in your home during flooding. Stay informed about flooding conditions by monitoring local radio and television stations. You must be prepared to evacuate when necessary.
- Elevating your home may reduce the cost of your NFIP flood insurance policy. Relocating a home to a site outside the regulatory floodplain eliminates the flood insurance purchase requirement and significantly reduces the cost of flood insurance for an owner who wishes to purchase a policy. Buying flood insurance is strongly recommended, even when it is not required.

3.3 Construction Terminology

In the remainder of this guide, you will find many references to common types of home construction, such as frame or masonry, and common types of home foundations, such as slab-on-grade or crawlspace. Even if you are already familiar with these and other home construction terms, take a minute to review the following information before you move to the descriptions of the retrofitting methods.

3.3.1 Construction Type

The most common home construction types are (Figure 3-1):

frame – walls constructed of wood or light-gauge metal studs, with wood, vinyl, or aluminum siding

masonry veneer – frame walls with a non-structural, decorative, exterior layer of brick, stone, or concrete block instead of siding

masonry – walls constructed of brick, stone, or concrete block

modular home – frame home assembled on site on a permanent foundation from separate sections manufactured elsewhere (subject to local building codes)

manufactured home – prefabricated frame home constructed on a transportable frame that can be placed on a permanent or temporary foundation (subject to Federal and State standards)

Some homes consist of combinations of two or more of these construction types.

Figure 3-1. Typical cross-sections of three common construction types: frame, masonry veneer, and masonry. The foundation shown here for all three construction types consists of concrete blocks and a concrete footing. The same construction types are also found on basement and slab-on-grade foundations.

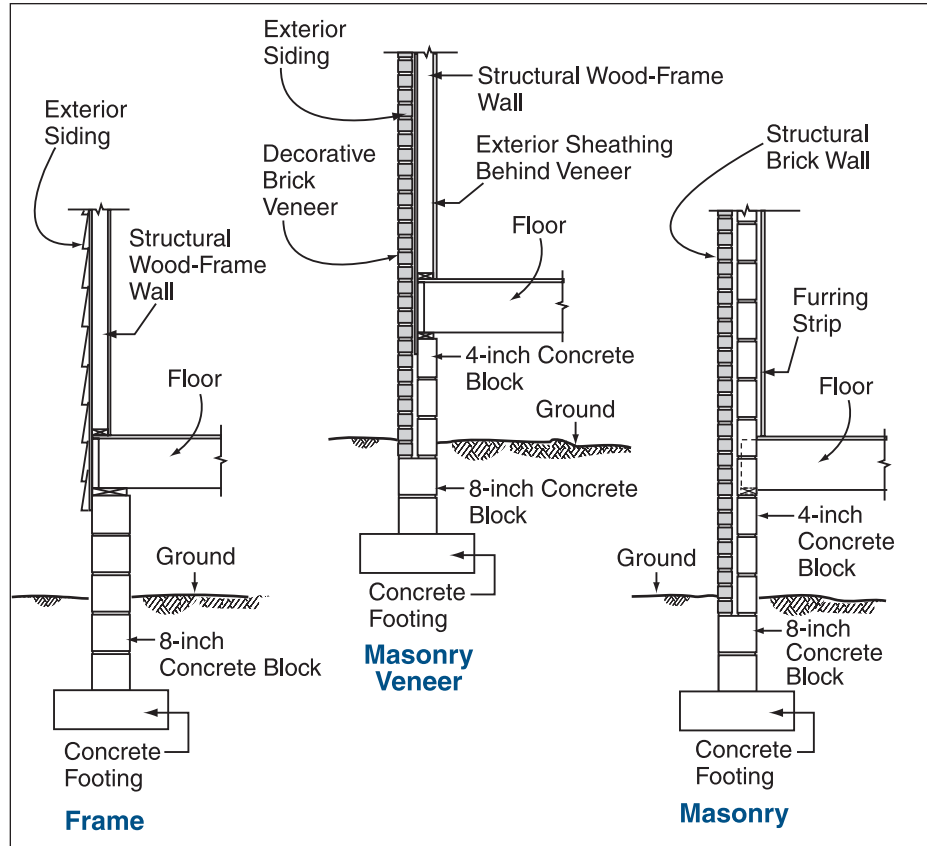

3.2.2 Foundation Type

Most homes of the construction types listed above are built on the following types of foundations (Figure 3-2):

basement – with masonry or **cast-in-place** concrete walls

crawlspace – with masonry or cast-in-place concrete walls

slab-on-grade – either (1) a slab with a masonry or concrete foundation or (2) a thickened slab (see Figure 5-5 in Chapter 5)

open foundation – usually concrete or masonry piers, but sometimes wood, concrete, or metal posts, columns, or piles

DEFINITION
Concrete poured into forms at the construction site is referred to as **cast-in-place**.

Some homes are built on more than one type of foundation. Various combinations of basement, crawlspace, and slab-on-grade foundations are common. Manufactured homes are occasionally installed on basement or crawlspace foundations but are more often supported either by stacks of concrete blocks or by foundation systems designed specifically for manufactured homes.

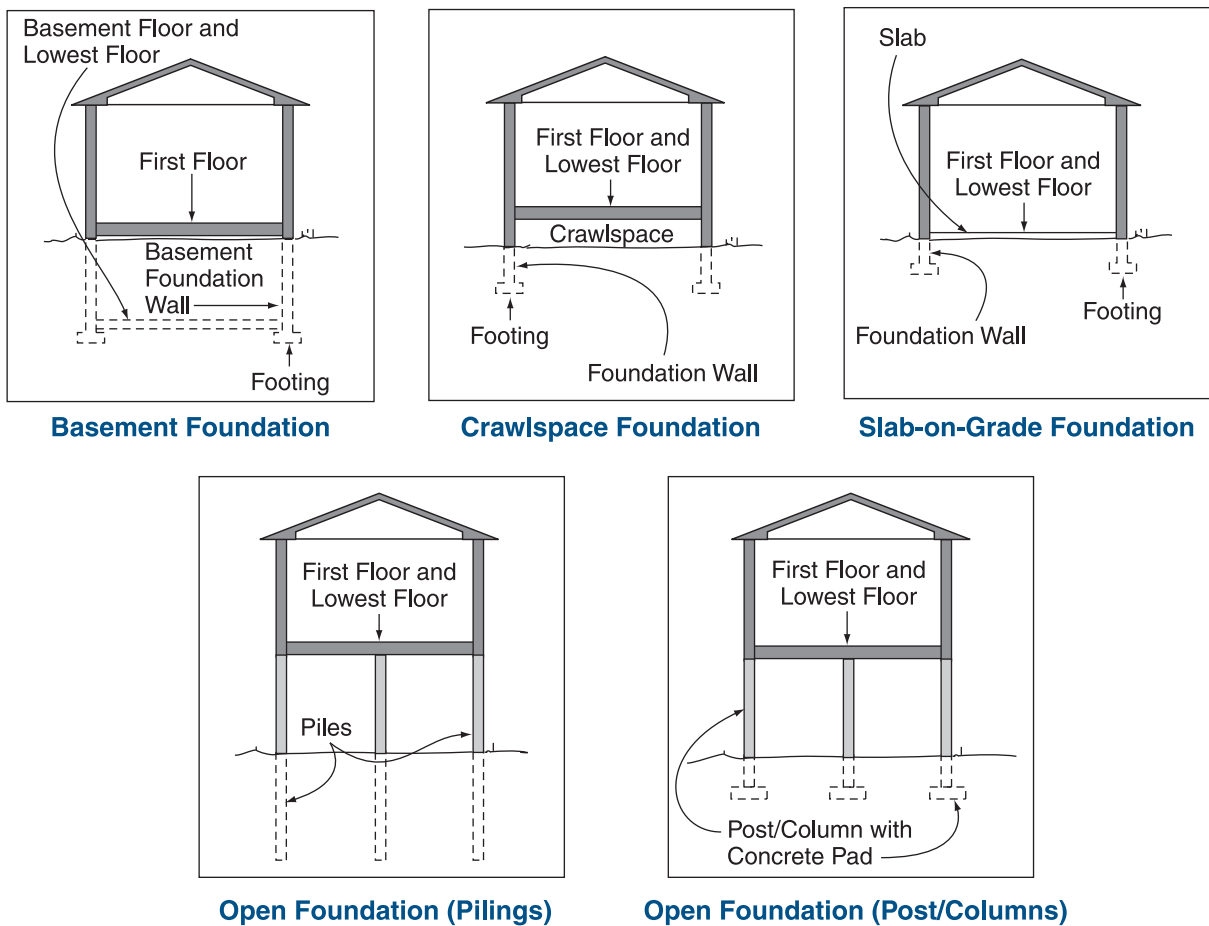

Figure 3-2. Home foundation types.

3.4 Retrofitting Methods and Costs

The following sections give an overview of the six retrofitting methods, explain how they work and where they are appropriate, and list their advantages and disadvantages. With this information, you will be ready for Chapter 4, *Deciding Which Method Is Right for Your Home*.



NOTE

FEMA 550, *Recommended Residential Construction for Coastal Areas: Building on Strong and Safe Foundations*, December 2009, offers more detail about foundations and elevation.

3.4.1 Elevation



Elevating a home to prevent floodwaters from reaching living areas is an effective retrofitting method. The goal of the elevation process is to raise the lowest floor to or above the DFE. You can do this by elevating the entire home, including the floor, or by leaving the home in its existing position and constructing a new raised floor within the home. The method used depends largely on construction type, foundation type, and flooding conditions. Chapter 5 presents more detailed information on elevation.

During the elevation process, most homes (including manufactured homes) are separated from their foundations, raised on hydraulic jacks, and held by temporary supports while a new or extended foundation is constructed below. This method works well for homes originally built on basement, crawlspace, and open foundations. As explained later in this section, the new or extended foundation can consist of continuous walls or separate piers, posts, columns, or piles.

For homes with slab-on-grade foundations, elevation can be done in one of two ways. One approach is to leave the home attached to the slab foundation and lift both together. After the home and slab are lifted, a new foundation is constructed below the slab. The other approach is to detach the home from the slab and elevate the home, leaving the slab foundation in place. After the home is lifted, a new, elevated floor is constructed.

Alternative techniques are available for masonry homes on slab-on-grade foundations. As described later in this section, these techniques do not require the lifting of the home. Instead, they involve raising the floor within the home or moving the living space to an upper story. Guidance for elevating slab-on-grade masonry homes can be found in FEMA 347, *Above the Flood: Elevating Your Floodprone House*.

Although elevating a home can help protect it from floodwaters, you need to consider other hazards before choosing this method. Elevating the home may cause it to become “top heavy” and,



WARNING

The approximate costs in this chapter are provided only as examples of what to expect when choosing a retrofitting method. They are based on past experience and 2009 national averages that may need to be adjusted for local economic conditions. Be sure to get a complete, written cost estimate from your contractor and design professional before you begin any retrofitting project (see Chapter 4).



NOTE

FEMA has produced a videotape titled *Best Build 3: Protecting a Flood-Prone Home*, which illustrates the retrofitting methods described in this guide (see Appendix A).

therefore, more susceptible to the overturning forces of earthquakes. In addition, both continuous wall foundations and open foundations can fail as a result of damage caused by erosion and the impact of debris carried by floodwaters. If portions of the original foundation, such as the **footings**, are used to support new walls or other foundation members, or a new second story, they must be capable of safely carrying the additional loads imposed by the new construction and the expected flood, wind, and earthquake forces.

Method #1: Elevating on Continuous Foundation Walls

This method is usually used in flood hazard areas where the risks of wave action and high-velocity flow are low (Figures 3-3 and 3-4). After the home is detached from its foundation and jacked up, the existing foundation is often saved and the existing foundation walls are extended. The new portions of the walls are usually made of masonry block or cast-in-place concrete. Although in many cases it is the easiest way to elevate a home, this method may involve some additional construction modifications or reinforcements.

Depending on the size of your home, the amount of elevation, and the magnitude of the potential environmental loads (such as those from floods, wind, earthquakes, and snow), your contractor may have to modify or reinforce the footings and foundation walls to ensure the structural stability of the home. The original footings may have to be replaced with larger footings. It may also be necessary to reinforce both the footings and the foundation walls with steel bars.

This type of foundation creates what is referred to under the NFIP as an “enclosure.” The enclosure must be constructed of flood damage-resistant materials, have all service equipment elevated above the design flood elevation, and be used only for parking, building access, or storage. The enclosure must also be constructed with openings to allow equalization of hydrostatic pressure to comply with NFIP and building code requirements. As explained in Chapter 2, unequalized hydrostatic pressure exerted by floodwaters can collapse walls, regardless of the construction materials used. The NFIP may require that openings be installed in the foundation walls so that water can flow into and out of any enclosed area below the newly elevated home. FEMA



DEFINITION

A **footing** is the base of a foundation. Footings are usually made of concrete and may be reinforced with steel bars. Foundation walls are supported on continuous footings; separate foundation members, such as piers, are supported on individual footings.

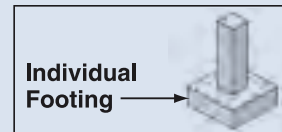
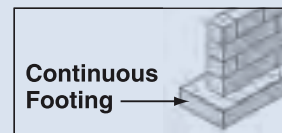

NOTE

When you elevate your home, the existing foundation will need to be extended or demolished and rebuilt. This decision will depend on the state of the existing foundation and its ability to carry additional loads.

Technical Bulletin 1, *Openings in Foundation Walls and Walls of Enclosures*, provides guidance on the NFIP regulations concerning openings in foundation walls. When the water levels on both sides of the foundation walls are the same, the hydrostatic pressure is equalized. If you are elevating your home as part of a substantial improvement or in connection with repairs of substantial damage, your community’s floodplain management ordinance or law will require that you install openings in all areas below the BFE. Consult your local officials about local requirements for openings.

Figure 3-3. Typical cross-section of home elevated on continuous foundation walls.

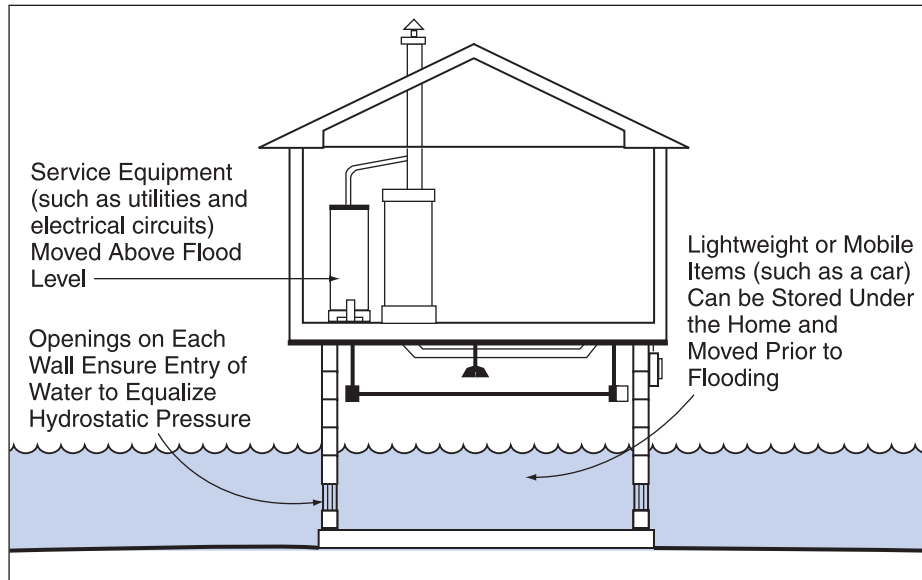

Figure 3-4. Retrofitted home elevated on extended continuous foundation walls.



Method #2: Elevating on Open Foundations

Unlike continuous foundations, open foundations consist of individual vertical structural members that support the home only at key points. Because they present less of an obstacle to flood flows than continuous walls, open foundations can be used in areas where there are risks of wave action and high-velocity flood. Most open foundations consist of piers, posts, columns, or piles.

Piers. The most common type of open foundation is a pier foundation. Piers are built with masonry block or are made of cast-in-place concrete. The bottom of each pier sits on a concrete footing. Pier foundations are used in conventional construction; they are not just a means of elevating a flood-prone home. In conventional use, they are designed primarily for vertical loading – to hold the weight of the home. They are not normally designed to resist large horizontal forces – such as those associated with moving floodwaters, waves, impacts from floodborne debris, wind, and earthquakes. As a result, pier foundations are generally used where the risks of wave action and high-velocity flow are low to moderate and the potential for earthquakes is low.

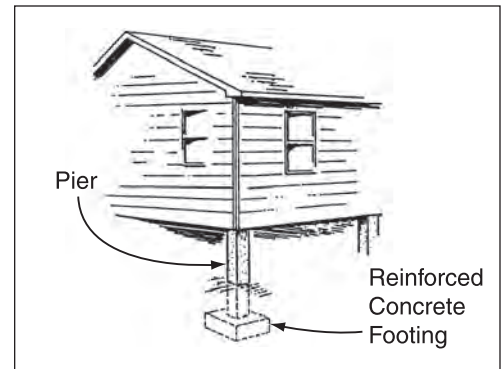

Home elevated on piers.

If you decide to elevate your home on a pier foundation, you should expect your contractor to reinforce the piers and footings with steel rods and to tie the piers to the footings so they will not separate under flood or other forces. Adequate connections between the piers and the home are also necessary so that the home and foundation will resist lateral loads from floods, winds, and earthquakes, and uplift from buoyancy.

Posts or columns. Posts (also referred to as columns) are usually made of wood or steel. They are generally square but may also be round. Posts and columns are set in holes, and their ends are encased in concrete, or supported on concrete pads (as in the figure). After posts or columns are set, the holes are filled with concrete, dirt, gravel, or crushed stone. Unlike piers, which are designed to act as independent supports, posts and columns usually must be connected to each other with bracing. The bracing may consist of wood, steel rods, or guy wires. The type you use is usually determined by cost, flood conditions, expected loads, the availability of materials, and local construction practices. Like piers, posts and columns are generally used where the risks of wave action and high-velocity flow are low to moderate.

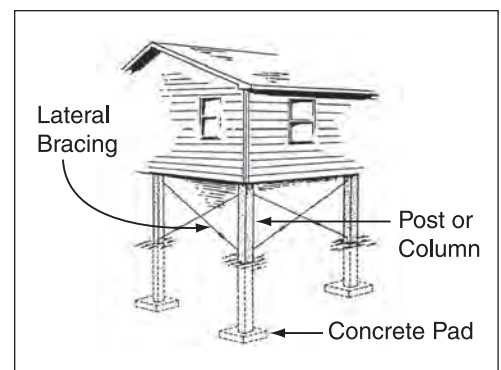

Home elevated on posts or columns.

Piles. Piles are usually made of wood, but steel and **pre-cast** concrete piles are also common in some areas. Piles are similar to posts but, instead of being set in holes, they are driven into the ground or jetted in with streams of water. Also, piles are embedded deeper in the ground than either piers or posts. As a result, pile foundations are less susceptible to the effects of high-velocity flow, waves, debris impact, erosion, and scour than the other types of open foundations. Piles differ from piers and posts also in that they do not rest on footings. Instead they are driven until they rest on a solid support layer, such as bedrock, or until they are embedded deep enough that the friction between the ground and the piles will enable them to resist the loads that are expected to act on them.

Because driving and **jetting** piles requires bulky, heavy construction machinery, an existing home must normally be moved off its existing foundation and set on **cribbing** until the operation is complete. As a result, elevating a home by placing it on a pile foundation will usually require more space and cost more than elevating with another type of foundation. Pile foundations are used primarily in areas where other elevation methods are not feasible, such as where floodwaters are deep and the risks of wave action and high-velocity flow are great. For example, pile foundations are used extensively in oceanfront areas exposed to high-velocity flow, waves, and high winds (Figure 3-5).

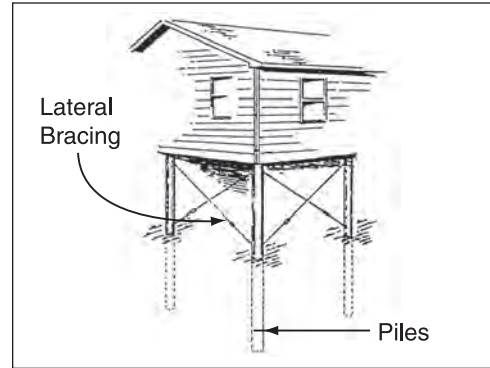

Home elevated on piles.



DEFINITION

Concrete materials such as posts, beams, and blocks that are brought to the construction site in finished form are referred to as **precast**.

Jetting is a process in which the hole for the installation of a pile is made by a high-pressure stream of water from a nozzle attached to the bottom of the pile.

Cribbing usually consists of a framework of criss-crossed timbers that provides temporary structural support.

Figure 3-5. This coastal home was elevated on piles so that it is less vulnerable to damage from coastal flooding.



Methods #3 and #4: Elevating by Extending the Walls of the Home or Moving the Living Space to an Upper Floor

For masonry homes on slab-on-grade foundations, two alternative elevation methods are available. One is to remove the roof, extend the walls of the home upward, replace the roof, and build a new, raised floor at the DFE (Figure 3-6). This technique works best where the floor needs to be raised less than 4 feet to reach the DFE. The floor can be either a new slab or a new wood-framed floor. For a new slab, fill dirt is placed on top of the old slab and the new slab is built on top. If a new wood-framed floor is built, the space between it and the old slab is left open and becomes a crawlspace (and must be retrofitted with openings to allow floodwaters in the crawlspace).



Figure 3-6. The owner of this flood-prone home in south Florida decided to build a new wood-framed second story on top of his masonry first story. The new second story is well above the BFE.

The second technique is to abandon the entire lower floor, or lower enclosed area, of the home and move the living space to an existing or newly constructed upper story. This technique works best for multi-story homes where the DFE is more than 4 feet above the level of the lower floor. The abandoned lower floor or enclosed area is then used only for parking, building access, or storage.

These techniques, like the others, have their limitations. The portions of the home below the DFE will be exposed to flooding and must therefore be made of flood damage-resistant materials. That is why this method is applicable to masonry homes rather than frame homes, which would be much more easily damaged by flooding. The area below the DFE cannot be used for living space; it may be used only for parking, building access, or storage. In addition, all appliances and utilities must be moved to the upper floor. Also, openings must be cut into the walls of the lower floor to allow water to enter during flooding so that the hydrostatic pressure on the walls will be equalized. In essence, the lower floor is wet floodproofed (see Section 3.4.2).

Table 3-1 presents the advantages and disadvantages of elevation.

Table 3-1. Advantages and Disadvantages of Elevation

Advantages	Disadvantages
<ul style="list-style-type: none"> • Elevation to or above the BFE allows a substantially improved or substantially damaged home to be brought into compliance with a community’s floodplain management ordinance or law. • Elevation reduces the flood risk to the home and its contents. • Except where a lower enclosed area is used for storage, elevation eliminates the need to move vulnerable contents to areas above the water level during flooding. • Elevation often reduces flood insurance premiums. • Elevation techniques are well known, and qualified contractors are often readily available. • Elevation does not require the additional land that may be needed for the construction of levees or floodwalls. • Elevation reduces the physical, financial, and emotional strain that accompanies floods. 	<ul style="list-style-type: none"> • Cost may be high. • Appearance of the home may be affected. • Access to the home may be affected. • The home must not be occupied during a flood. • Unless special measures are taken, elevation is not appropriate in areas with high-velocity flows, waves, fast-moving ice or debris flow, or erosion. • Additional costs are likely if the home must be brought into compliance with current code requirements for plumbing, electrical, and energy systems.

Adding a new second story to a single-story home may require that the foundation be strengthened so that it can support the additional load. You must consult an engineer if you plan to use this method. The second story can be frame or masonry (to match the lower floor). The method you choose will depend on the advice of your engineer, cost, appearance, the availability of materials and experienced contractors, and the risks of other natural hazards such as hurricanes and earthquakes.

Approximate Costs

The relative costs shown in Table 3-2 are for elevating frame, masonry veneer, and masonry homes of various foundation types. The costs for extending utilities and adding or extending staircases are included. The costs shown for elevating frame, masonry veneer, and masonry homes on existing slab-on-grade foundations are based on the assumption that the home is raised with the existing slab attached.



NOTE

As discussed in Section 2.7, the cost of elevating a substantially damaged home may be eligible for a flood insurance claim under ICC coverage.

Table 3-2. Relative Costs of Elevating a Home

Construction Type	Existing Foundation	Retrofit	Relative Cost
Frame	Basement, Crawlspace, or Open Foundation	Elevate on Continuous Foundation Walls or Open Foundation	Lowest  Highest
Masonry Veneer		Elevate on Continuous Foundation Walls or Open Foundation	
Masonry		Extend Existing Walls and Create New Elevated Living Area	
Frame	Slab-on-Grade	Elevate on Continuous Foundation Walls or Open Foundation	
Masonry Veneer		Elevate on Continuous Foundation Walls or Open Foundation	
Masonry		Elevate on Continuous Foundation Walls or Open Foundation	



DEFINITION

The **footprint** of a home is the land area it covers (see figure). This area is equal to the length of the home multiplied by its width. Note that the footprint is not necessarily equal to the total square footage of the home.

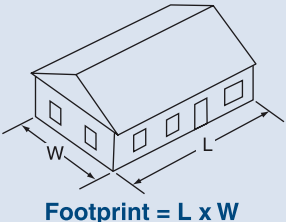

Occasionally, slab-on-grade homes are raised without the slab. Although this method can be less expensive than raising the home with the slab, it involves detaching the home from the slab and requires extensive alterations to interior and exterior walls.

The cost of abandoning an existing lower level will depend on whether the home already has an upper level that can be used for living space. If an upper level is available, abandoning the lower floor would involve primarily elevating or relocating utilities, adding openings in the lower-level walls, and ensuring that all construction materials below the BFE are **flood damage-resistant**. This method is well-suited to a home with a walkout-on-grade basement, which can be wet floodproofed and used for parking, building access, or storage. The cost of adding a new frame upper level and raising the roof to accommodate the new level would vary, depending upon the amount of interior finishing and other factors. Table 3-3 shows approximate costs for some elevation projects. The costs for extending utilities and adding or extending staircases are included. The costs shown for elevating frame and masonry houses on existing slab-on-grade foundations are based on the assumption that the house is raised with the existing slab attached.

Table 3-3. Approximate Square Foot Costs of Elevating a Home (2009 Dollars)

Construction Type	Existing Foundation	Retrofit	Cost (per square foot of house footprint)
Frame (for frame house with brick veneer on walls, add 10 percent)	Basement or Crawlspace	Elevate 2 Feet on Continuous Foundation Walls or Open Foundation	\$29
		Elevate 4 Feet on Continuous Foundation Walls or Open Foundation	\$32
		Elevate 8 Feet on Continuous Foundation Walls or Open Foundation	\$37
	Slab-on-Grade	Elevate 2 Feet on Continuous Foundation Walls or Open Foundation ¹	\$80
		Elevate 4 Feet on Continuous Foundation Walls or Open Foundation ¹	\$83
		Elevate 8 Feet on Continuous Foundation Walls or Open Foundation ¹	\$88
Masonry	Basement or Crawlspace	Elevate 2 Feet on Continuous Foundation Walls or Open Foundation	\$60
		Elevate 4 Feet on Continuous Foundation Walls or Open Foundation	\$63
		Elevate 8 Feet on Continuous Foundation Walls or Open Foundation	\$68
	Slab-on-Grade	Elevate 2 Feet on Continuous Foundation Walls or Open Foundation ¹	\$88
		Elevate 4 Feet on Continuous Foundation Walls or Open Foundation ¹	\$91
		Elevate 8 Feet on Continuous Foundation Walls or Open Foundation ¹	\$96

¹Price shown is for raising the house with the slab attached.

3.4.2 Wet Floodproofing



Wet floodproofing a home is modifying the uninhabited portions of the home (such as a crawlspace or other enclosure, or basement) so that floodwaters will enter but not cause significant damage to either the home or its contents. The purpose of allowing water into portions of the home is to ensure that the interior and exterior hydrostatic pressures will be equal. Allowing these pressures to equalize greatly reduces the likelihood of wall failures and structural damage. Wet floodproofing may be used when other retrofitting methods are either too costly or are not feasible. If you intend to wet floodproof your basement, a licensed engineer or design professional is needed to determine the structural integrity of the walls. But wet floodproofing is practical in only a limited number of situations; however, only in certain situations can it be used to meet the NFIP requirements. Chapter 6 presents more detailed information on wet floodproofing.

Because wet floodproofing allows floodwaters to enter the home, all construction and finishing materials below the DFE should be resistant to flood damage. For this reason, wet floodproofing is practical only for portions of a home that are not used for living space, such as a basement as defined by the NFIP regulations, an enclosure such as a walkout-on-grade basement or a crawlspace, or an attached garage. Figure 3-7 illustrates a home with a wet floodproofed subgrade basement. Wet floodproofing this home protects it from hydrostatic pressure, but not hydrodynamic pressure and floodborne debris. To minimize damages, service equipment should be elevated above the flood level and the walls of the basement should be built with **flood damage-resistant materials**.



WARNING

After floodwaters recede from around a home with a wet floodproofed basement, you will need to pump out the water that filled the basement during the flood. However, there are certain precautions you need to take before you pump out the water. If the soil surrounding the basement walls and below the basement floor is still saturated with water, removing the water in the basement too quickly can be dangerous. As the water level in the basement drops, the outside pressure on the basement walls and floor becomes greater than the inside pressure (see figure). As a result, the walls can collapse and the floor can be pushed up or cracked (see Section 2.6). If you are unsure whether it is safe to pump out your basement, contact a licensed dewatering contractor.

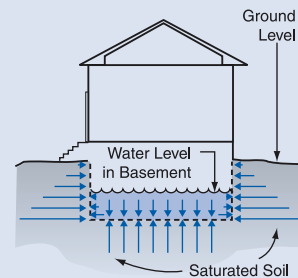

NOTE

See Section 6.3.2 for a discussion of **flood damage-resistant materials**.

Figure 3-7. A home with a wet floodproofed subgrade basement. (If this home were substantially improved or substantially damaged, the basement would have to be filled in; see the Warning below.)

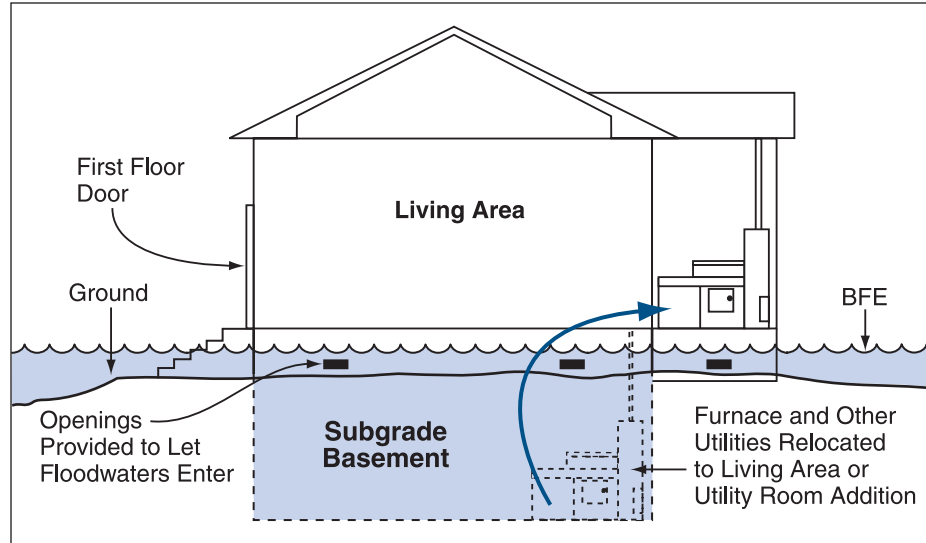



Figure 3-8 illustrates a home in which the lower level was modified to create an enclosure that is built with flood damage-resistant materials, has service equipment elevated above the flood level, and is used solely for parking, building access, or storage. As illustrated in Figure 3-8, openings need to be placed in the walls to relieve hydrostatic pressure. If the lowest elevated floor is above the community’s DFE and the enclosure is protected as described above, the home would meet the minimum requirements of the NFIP. Wet floodproofing would not be practical for most slab-on-grade homes, in which the living space is at or very near the ground level. Whether or not wet floodproofing is appropriate for your home will depend on the flood conditions, the DFE you have selected, the design and construction of your home, and whether you are required to bring your home into compliance because it is being substantially improved or has been substantially damaged.



WARNING

Wet floodproofing may not be used to bring a substantially improved or substantially damaged home into compliance. If your home is being substantially improved or has been substantially damaged, your community’s floodplain management ordinance or law will restrict your use of wet floodproofing to attached garages and enclosed areas below the BFE that are used solely for parking, building access, or storage. For more information, consult your local officials.

If you are considering wet floodproofing, keep the following in mind:

- Your home should have space above the DFE in which you can temporarily or permanently store items that could be damaged by floodwaters.
- If your furnace, water heater, or other service equipment is below the DFE, it should be protected as well. You may be able to do this by moving the equipment to another floor, elevating it, or protecting it in place. (An example of protection in place is surrounding a furnace with an interior floodwall; see Chapter 8.)

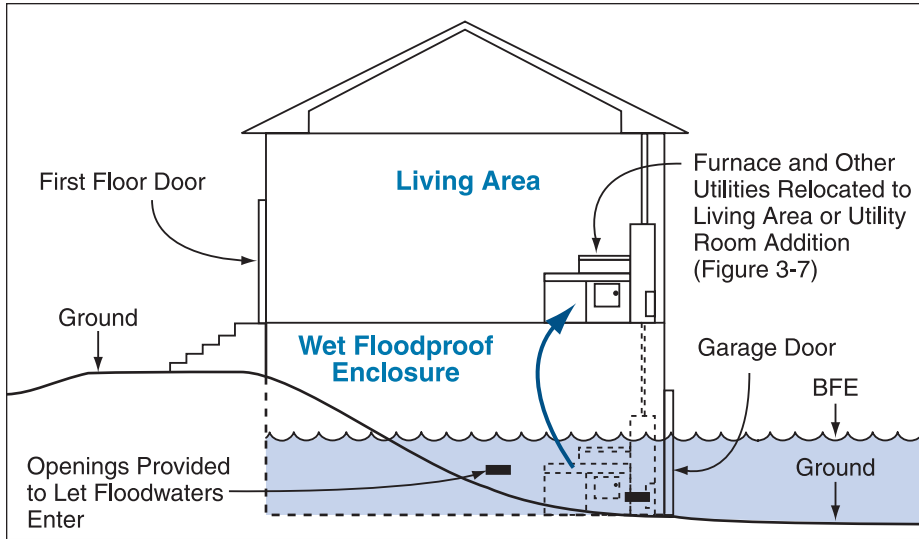



Figure 3-8. A home with a wet floodproofed enclosure (see Note below).

- Any construction and finishing materials below the DFE that are not **flood damage-resistant** should be removed or replaced with materials that are flood damage-resistant.
- If a flood occurs, you will not be able to live in your home as long as floodwaters remain inside.
- Wet floodproofing does not alleviate the threat of damage from high-velocity flood flow and wave action.
- Your community’s floodplain management ordinance or law will not allow you to wet floodproof your basement as defined under the NFIP if your home has been substantially damaged or is being substantially improved.



NOTE

The approach shown in Figure 3-8 may be used to meet the minimum requirements of the NFIP provided the walkout-on-grade basement use is restricted to parking, building access, or storage and construction and finish materials are flood damage-resistant.

Table 3-4 illustrates the advantages and disadvantages of wet floodproofing.

Table 3-4. Advantages and Disadvantages of Wet Floodproofing

Advantages	Disadvantages
<ul style="list-style-type: none"> No matter how small the effort, wet floodproofing can, in many instances, reduce flood damage to a home and its contents. Because wet floodproofing reduces risk of structural collapse as hydrostatic pressures are allowed to equalize, the loads on walls and floors will be less than in a dry floodproofed home (discussed later in this section). 	<ul style="list-style-type: none"> Preparing the home and its contents for an impending flood requires human intervention and adequate warning time. The home will get wet inside and possibly be contaminated by sewage, chemicals, and other materials borne by floodwaters. Extensive cleanup may be necessary.

Table 3-4. Advantages and Disadvantages of Wet Floodproofing (continued)

Advantages	Disadvantages
<ul style="list-style-type: none"> Wet floodproofing measures are often less costly than other types of retrofitting. Wet floodproofing does not require the additional land that may be needed for levees and floodwalls (discussed later in this section). The appearance of the home is usually not adversely affected. Wet floodproofing reduces the physical, financial, and emotional strain that accompanies floods. 	<ul style="list-style-type: none"> The home must not be occupied during a flood, and it may be uninhabitable for some time afterward. It will be necessary to limit the use of the floodable area of the home. Periodic maintenance may be required. Pumping floodwaters out of a wet floodproofed basement too soon after a flood may lead to structural damage (see the Warning on page 3-21). Wet floodproofing does not minimize the potential damage from high-velocity flood flow and wave damage.

Wet floodproofing is generally less expensive than the other flood protection methods described in this guide. Table 3-5 shows the relative approximate costs of wet floodproofing homes on basement and crawlspace foundations to heights between 2 feet and 8 feet. In a home with a basement, this height is measured from the basement floor (but see the warning on page 3-22). In a home with a crawlspace, this height is measured from the **lowest grade adjacent to the home**. The relative costs include those for adding wall openings for the entry and exit of floodwaters, installing pumps, rearranging or relocating utility systems, moving large appliances, and making it easier to clean up after floodwaters recede. The relative costs shown for basements in Table 3-5 are valid only for unfinished basements. Wet floodproofing a finished basement would involve the removal of all non-flood damage-resistant materials and replacing finish materials with flood damage-resistant materials. As a result, wet floodproofing costs for finished basements would be higher and would vary, depending on the amount of finish material to be removed or replaced. Table 3-6 shows approximate costs for some wet floodproofing projects.



DEFINITION

The **lowest adjacent grade (LAG)** is the lowest ground surface that touches any of the exterior walls of a home.

Table 3-5. Relative Costs of Wet Floodproofing

Construction Type	Existing Foundation	Retrofit	Relative Cost
Frame, Masonry Veneer, or Masonry	Crawlspace	Wet floodproof crawlspace to a height of 2 feet to 4 feet above LAG	Lowest  Highest
	Basement	Wet floodproof unfinished basement to a height of 2 feet to 4 feet above the basement floor	
	Basement	Wet floodproof unfinished basement to a height of 8 feet above the basement floor	

Table 3-6. Approximate Costs of Wet Floodproofing (2009 Dollars)

Construction Type	Height of Wet Floodproofing (in feet above basement floor or LAG ¹)	Existing Foundation	Cost (per square foot of house footprint)
Frame or Masonry	2	Basement ²	\$2.90
		Crawlspace	\$2.20
	4	Basement ²	\$6.00
		Crawlspace	\$5.60
	8	Basement ²	\$17.00
		Crawlspace	NA ³

¹ Measured in feet above basement floor for house with basement and feet above **lowest adjacent grade (LAG)** for house with crawlspace.

² Unfinished basements.

³ No price shown since a house would almost never have a crawlspace 8 feet high, which is nearly the height of a full story.

3.4.3 Relocation



Moving your home to high ground, outside the flood hazard area, is the most effective of the retrofitting methods described in this guide. Retrofitting literature commonly refers to this method as relocation. Chapter 7 presents more detailed information on relocation. When there is enough space and the ground is high enough, you may even be able to move your home to another location on the same piece of property.

Relocating a home involves detaching it from the foundation, jacking it up, and placing it on a wheeled vehicle that delivers it to the new site. The original foundation is demolished and a new foundation is built at the new site. The home is installed on the new foundation and all utility lines are connected. Relocation is particularly appropriate in areas where the flood hazard is severe, such as where flood conditions are characterized by one or more of the following:

- deep water
- rapid rates of rise and fall
- short warning time
- wave action
- high flow velocity
- high debris potential
- long duration
- erosion

Relocation is also appropriate for homeowners who want to be free of worries about damage from future floods that may exceed a selected DFE.

Although similar to elevation, relocation requires additional steps that usually make it more expensive. These include moving the home, buying and preparing a new site (including building the new foundation and providing the necessary utilities), and restoring the old site (including demolishing the old foundation and capping and abandoning old utility lines).

Homes of all sizes and types can be relocated, either as a unit or in segments. One-story frame homes are usually the easiest to move, particularly if they are built on a crawlspace or basement foundation that provides easy access to the floor framing. Masonry homes can also be moved, but usually with more difficulty and at a higher cost.

Professional home movers can advise you about the things you need to consider when deciding whether to relocate. The structural soundness of your home will have to be checked. Also, you may need to find a place where you can store furniture and other belongings temporarily. In most instances, however, the contents of your home may remain in the home while it is being moved. Keep in mind that there must be a clear route to the new site. Narrow roads, restrictive overpasses, and bridges with low weight limits may make it impossible for your home to be moved to the new site. Also, many States and communities have requirements that govern the transport of homes and other buildings on public rights-of-way. For information about structural movers in your area, visit <http://www.iasm.org>.

Table 3-7 presents the advantages and disadvantages of relocation.

Table 3-7. Advantages and Disadvantages of Relocation

Advantages	Disadvantages
<ul style="list-style-type: none"> • Relocation allows a substantially improved or substantially damaged home to be brought into compliance with a community's floodplain management ordinance or law. • Relocation significantly reduces flood risk to the home and its contents. • Relocation can either eliminate the need to purchase flood insurance or reduce the amount of the premium. • Relocation techniques are well known, and qualified contractors are often readily available. • Relocation reduces the physical, financial, and emotional strain that accompanies flood events. 	<ul style="list-style-type: none"> • Cost may be significant. • A new site (preferably outside the flood hazard area) must be located and purchased. • The flood-prone lot on which the home was located must be sold or otherwise disposed of if you do not want to maintain the old lot. • Additional costs are likely if the home must be brought into compliance with current code requirements for plumbing, electrical, and energy systems.

Table 3-8 shows the relative costs of relocating homes of different construction and foundation types. In addition to moving and construction costs, it is important to account for the additional relocation project costs of any new property that must be purchased. Table 3-9 shows approximate costs for some relocation projects. The costs in Table 3-9 do not include the cost of purchasing new property. The costs include detaching the home from its foundation, moving the home, building a new foundation at the new site, installing the home on the new foundation, and hooking up all utilities. The costs shown are based on the assumption that the home will be moved less than 5 miles and installed on the same type of foundation it had at its original location.

**NOTE**

As discussed in Section 2.7, the cost of relocating a substantially damaged home may be an eligible flood insurance claim under ICC coverage.

Table 3-8. Relative Costs of Relocation

Construction Type	Existing Foundation	Retrofit	Relative Cost
Frame	Crawlspace or Open Foundation	Relocate existing home and install the home on a new foundation at the new site, hook up utilities, and restore the old site.	Lowest  Highest
Masonry Veneer			
Masonry			
Frame	Basement		
Masonry Veneer			
Masonry			
Frame	Slab-on-Grade		
Masonry Veneer			
Masonry			



WARNING

The relative relocation costs shown here are based on a small home. Because relocation costs do not increase proportionally with the size of a home, the cost per square foot of moving a larger home may be less than that shown here.

Table 3-9. Approximate Costs of Relocation (2009 Dollars)

Construction Type	Existing Foundation	Cost ¹ (per square foot of house footprint)
Frame (for frame house with brick veneer on walls, add 10 percent)	Basement	\$67
	Crawlspace	\$58
	Slab-on-Grade	\$99
Masonry	Basement	\$96
	Crawlspace	\$67
	Slab-on-Grade	\$116

¹ Prices shown include cost to restore old site (\$12/square foot), but do not include the cost of any new property that must be purchased.

3.4.4 Dry Floodproofing



In some situations, a home can be made watertight below the DFE, so that floodwaters cannot enter. This method is called “dry floodproofing.” Section 7.3 presents more detailed information on dry floodproofing. Making the home watertight requires sealing the walls with waterproof coatings, impermeable membranes, or supplemental layers of masonry or concrete. Also, doors, windows, and other openings below the DFE must be equipped with permanent or removable shields, and backflow valves must be installed in sewer lines and drains. The flood characteristics that determine whether dry floodproofing is effective are flood duration, flow velocity, and the potential for wave action and floodborne debris. You should consult a design professional before undertaking a dry floodproofing project.



WARNING

Dry floodproofing may not be used to bring a substantially improved or substantially damaged home into compliance with your community’s floodplain management ordinance or law.

Figure 3-9 shows a typical dry floodproofed home and Table 3-10 presents the advantages and disadvantages of dry floodproofing.

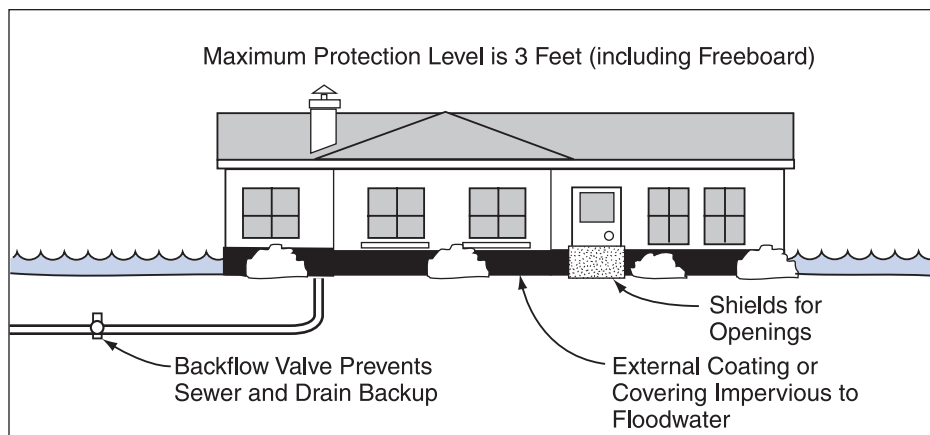

Figure 3-9. A typical dry floodproofed home.

Flood depth is important to know because of the hydrostatic pressure that floodwaters exert on walls and floors. Because water is prevented from entering a dry floodproofed home, the exterior pressure on walls and floors is not counteracted as it is in a wet floodproofed home (see the discussion in Section 3.4.2). The ability of a home’s walls to withstand the pressure exerted by floodwaters depends partly on how the walls are constructed. Typical masonry and masonry veneer walls, without reinforcement, can usually withstand the pressure exerted by water up to about 3 feet deep. When flood depths exceed 3 feet, unreinforced masonry and masonry veneer walls are much more likely to crack or collapse. An advantage of masonry and masonry veneer

walls is that their exterior surfaces are resistant to damage by moisture and can be made watertight relatively easily with sealants. In contrast, typical frame walls are likely to fail at lower flood depths, are more difficult to make watertight, and are more vulnerable to damage from moisture. As a result, dry floodproofing is not recommended for homes with frame walls.

Even if masonry or masonry veneer walls are reinforced to withstand the pressure of deeper water, the effects of buoyancy must be considered. The buoyancy force exerted by water greater than 3 feet deep is often enough to crack a slab floor or push it up. For this reason, dry floodproofing is not an appropriate method of protecting a home from flooding over 3 feet deep.



WARNING

Even concrete block and brick walls should not be dry floodproofed above a height of 3 feet, unless an engineering analysis has been performed that shows that the walls will withstand the expected hydrostatic and hydrodynamic loads and debris impact forces. The effects of buoyancy on slab floors must also be considered.



WARNING

Because dry floodproofing requires human intervention, you must be willing and able to install all flood shields and carry out all other activities required for the successful operation of the dry floodproofing system. As a result, not only must you be physically capable of carrying out these activities, you must be home or able to get home in time to do so before floodwaters arrive.

Table 3-10. Advantages and Disadvantages of Dry Floodproofing

Advantages	Disadvantages
<ul style="list-style-type: none"> • Dry floodproofing reduces the flood risk to the home and its contents. • Dry floodproofing may be less costly than other retrofitting methods. • Dry floodproofing does not require the additional land that may be needed for levees and floodwalls (discussed in Section 3.4.5). • Dry floodproofing reduces the physical, financial, and emotional strain that accompanies floods. 	<ul style="list-style-type: none"> • Dry floodproofing may not be used to bring a substantially improved or substantially damaged home into compliance with a community's floodplain management ordinance or law. • Ongoing maintenance is required. • Flood insurance premiums are not reduced for dry floodproofed residential structures. • Installing temporary protective measures, such as flood shields, requires human intervention and adequate warning time. • If the protective measures fail or the DFE is exceeded, the effect on the home will be the same as or worse than if there were no protection at all. • If design loads are exceeded, walls may collapse, floors may buckle, and the home may even float, potentially resulting in more damage than if the home were allowed to flood. • The home must not be occupied during a flood. • Waterproofing materials and flood shields may not be aesthetically pleasing. • Shields and sealants may leak, which could result in damage to the home and its contents. • Dry floodproofing does not minimize the potential damage from high-velocity flood flow and wave action. • Adequate warning time is required to close any openings.

Duration of flooding is critical because most sealing systems will begin to allow some seepage after prolonged periods of exposure to water. If your home is in an area where floodwaters remain high for 24 hours or longer, you should use a different retrofitting method. Dry floodproofing is not appropriate in areas with a risk of high-velocity flood flow, wave action, or both. Either condition may render dry floodproofing totally ineffective and cause severe damage.

Dry floodproofing is not recommended for homes with basements. Saturated soils pressing against basement walls can damage them or cause them to fail. The buoyancy force exerted by saturated soils below the basement can cause the basement floor to fail or even push the entire home up.

Sealant systems, especially those that rely on membranes and coatings, can be punctured by ice and other types of debris. If your home is in an area where floodwaters are known to carry debris, you should select a different retrofitting method.

The total cost for dry floodproofing a home will depend largely on the size of the home, the depth of flooding, types of sealant and shield materials used, number of plumbing lines that have to be protected by check valves, and number of openings that have to be covered by shields. Table 3-11 shows approximate costs for elements of a dry floodproofing project.

Table 3-11. Approximate Costs of Dry Floodproofing (2009 Dollars)

Component	Height of Dry Floodproofing	Cost	Per
Sprayed-on Cement (above grade) ¹	3 Feet	\$16.80	Linear Foot of Wall Covered
Waterproof Membrane (above grade) ¹		\$5.70	Linear Foot of Wall Covered
Asphalt (two coats on foundation up to 2 feet below grade) ¹		\$12.00	Linear Foot of Wall Covered
Drainage Line Around Perimeter of House		\$31	Linear Foot
Plumbing Check Valve		\$1,060	Each
Sump and Sump Pump (with backup battery)		\$1,710	Lump Sum
Metal Flood Shield		\$375	Linear Foot of Shield Surface
Wood Flood Shield		\$117	Linear Foot of Shield Surface

¹Cement, asphalt, and membrane are alternative sealant methods.

3.4.5 Levees and Floodwalls



Levees and floodwalls are types of flood protection barriers. A levee is a compacted earthen structure; a floodwall is an engineered structure usually built of concrete, masonry, or a combination of both (concrete masonry unit [CMU]). When these barriers are built to protect a home, they are usually referred to as “residential,” “individual,” or “on-site” levees and floodwalls. The practical heights of these levees and floodwalls are usually limited to 6 feet and 4 feet, respectively. These limits are the result of the following considerations:



WARNING

Levees and floodwalls may not be used to bring a substantially improved or substantially damaged home into compliance with your community’s floodplain management ordinance or law, and does not remove the insurance requirement on the home for Federally backed mortgages.

- As the height of a levee or floodwall increases, so does the depth of water that can build up behind it. Greater depths result in greater water pressures, so taller levees and floodwalls must be designed and constructed to withstand the increased pressures. Meeting this need for additional strength greatly increases the cost of the levee or floodwall, usually beyond what an individual homeowner can afford.
- Because taller levees and floodwalls must be stronger, they must also be more massive, so they usually require more space than is likely to be available on an individual lot. This is especially true of levees.
- Levees require a large land area for construction. For example, the levee in Figure 3-13 is 4 feet tall and about 27 feet wide.

Section 7.4 presents more detailed information on levees and floodwalls. Figure 3-10 shows a home protected by a levee and floodwall; Figure 3-11 shows a home protected by a levee. Remember that levees and floodwalls should be designed by a licensed engineer.

Both levees and floodwalls should provide at least 1 foot of **freeboard**. For example, if you are building a levee to protect your home from the base flood, the top of the levee should be at least 1 foot above the BFE.

For a levee to be effective over time, it must be constructed of soils that cannot be easily penetrated by floodwaters, it must have proper side slopes for stability, and it must be periodically inspected and maintained. In areas where high flow velocities could erode the surface of a levee, the side of the levee exposed to floodwater is usually protected with a covering of rock, referred to as **riprap**, or with other erosion-resistant material. Levees can surround a home, or they may be built only across low areas and tied into existing high ground.

A floodwall can surround a home or it can protect isolated openings such as doors, windows, and walkout-on-grade basements depending on flood depths, site topography, and design preferences. When built with decorative bricks or blocks or as part of garden areas, floodwalls can become attractive architectural or landscaping features. But they can also be built solely for utility, usually at a lower cost.

Because a floodwall is made of concrete or masonry rather than compacted earth, it is more resistant to erosion than a levee and generally requires less space than a levee to provide the same level of protection. But floodwalls are usually more expensive. As a result, floodwalls are normally considered only for sites where there is not enough room for a levee or where high



NOTE

Freeboard is explained in Section 3.2.4.



DEFINITION

Riprap refers to pieces of rock or crushed stone added to the surface of a fill slope, such as the side of a levee, to prevent erosion.

flow velocities may erode a levee. Also, some homeowners prefer floodwalls because they can be more aesthetically pleasing and allow for the preservation of existing site features, such as trees.

As shown in Figure 3-10, an interior drainage system, including a sump pump, must be installed in the area protected by a levee or floodwall. The purpose of the system is to remove rainwater trapped inside the protected area and, during flooding, to remove water that enters through seepage or infiltration.

It also may be necessary to include an opening in a levee or floodwall that will provide access for a car



WARNING

Special design considerations are necessary when levees or floodwalls are built to protect a home with a basement. Even though the surface water is kept from coming into contact with the home, the soil below the levee or floodwall and around the home can become saturated, especially during floods of long duration. The resulting pressure on basement walls and floors can cause them to crack buckle, or collapse.

Figure 3-10. A home protected by a levee (left) and a floodwall (right).

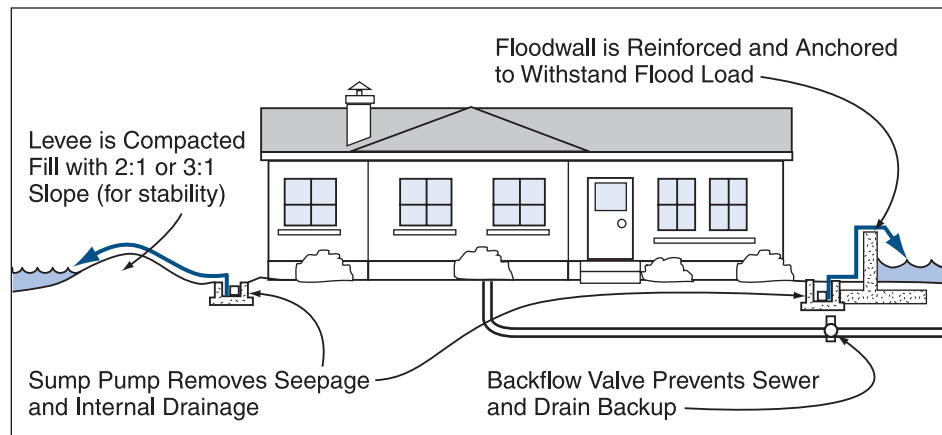

Figure 3-11. A home protected by a levee, which holds back the floodwaters shown in the lower half of the photograph. Note that the levee ties in to high ground created by the road embankment.



or other vehicle. All openings must be equipped with closures similar to those used in dry flood-proofing. Installing closures over openings in levees and floodwalls requires advance warning of flooding in most cases – in other words, levees and floodwalls generally require human intervention. One exception is a low, earthen levee that can be sloped to allow vehicle access.

Table 3-12 presents the advantages and disadvantages of levees and floodwalls. Figure 3-12 shows a home protected by a floodwall.

Table 3-12. Advantages and Disadvantages of Levees and Floodwalls

Advantages	Disadvantages
<ul style="list-style-type: none"> • The home and the area around it will be protected from inundation, and no significant changes to the home will be required. • Floodwaters cannot reach the house or other structures in the protected area and therefore will not cause damage through inundation, hydrodynamic pressure, erosion, scour, or debris impact. • The house can be occupied during construction of levees and floodwalls. • Levees and floodwalls reduce the physical, financial, and emotional strain that accompanies flood events. 	<ul style="list-style-type: none"> • Levees and floodwalls may not be used to bring a substantially improved or substantially damaged home into compliance with your community’s floodplain management ordinance or law. • Individual residential levees or floodwalls cannot be used to bring a home with a first floor elevation below the BFE into compliance with the NFIP. • Cost may be high. • Periodic maintenance is required. • Human intervention and adequate warning time are required to close any openings in a levee or floodwall. • If a levee or floodwall fails or is overtopped by floodwaters, the effect on the home will be the same as if there were no protection at all. • An interior drainage system must be provided. • Local drainage can be affected, possibly creating or worsening flood problems for others. • The home must not be occupied during a flood. • Access to the home may be restricted. • Levees and floodwalls do not reduce flood insurance rates. • Floodplain management requirements may not allow levees and floodwalls. • A large area may be required for construction, especially for levees. • Hydrostatic pressure on below-ground portions of the home may still be a problem, so levees and floodwalls are not good retrofitting methods for homes with basements.

Figure 3-12. A home protected by a floodwall designed as a landscaping feature.



Table 3-13 shows the relative costs for levees and floodwalls of various heights. Remember that additional costs of levee and floodwalls may include erosion protection using seeding or riprap, interior drainage, and installation of closures.

Table 3-13. Relative Costs of Levees and Floodwalls

Construction Type	Existing Foundation	Retrofit	Relative Cost
Frame, Masonry Veneer of Masonry	Basement, Crawlspace, Open Foundation or Slab-on-Grade	Levee constructed 2 feet above grade	Lowest  Highest
		Levee constructed 4 feet above grade	
		Floodwall constructed 2 feet above grade	
		Levee constructed 6 feet above grade	
		Floodwall constructed 4 feet above grade	

The approximate costs shown in Table 3-14 are based on an individual floodwall/levee that wraps around a home with a walkout basement. Figure 3-13 illustrates the dimensions of these structures.



NOTE

The costs for levee construction can vary greatly, depending on the distance between the construction site and the source of the fill dirt used to build the levee. The greater the distance that fill dirt must be hauled, the greater the cost.

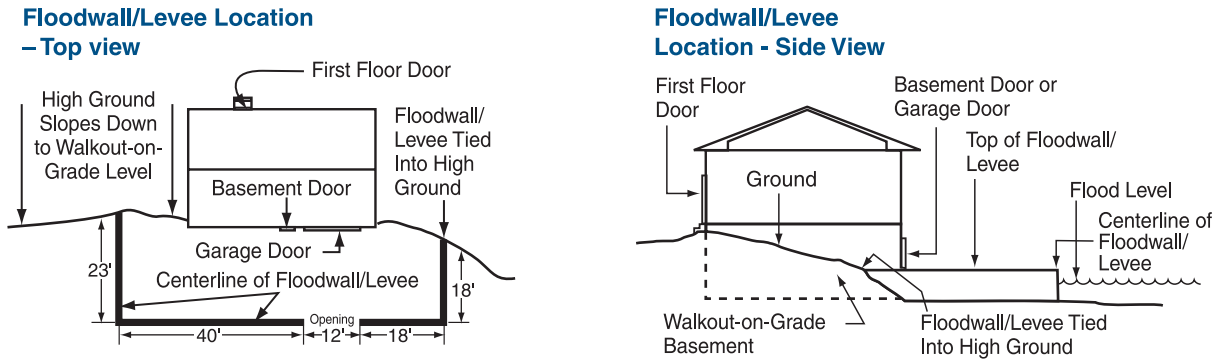

Cross-Section Showing Dimensions of a 4-Foot-High Levee

With a height of 4 feet and a slope of 2.5:1 the face of the levee on the water side would span 10.8 feet

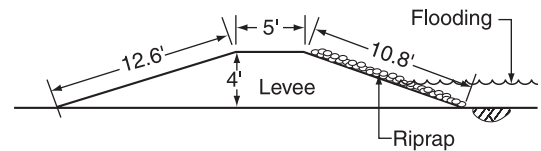

Figure 3-13. Floodwall and levee dimensions for approximate costs in Table 3-14.

Table 3-14. Approximate Costs of Levees and Floodwalls (2009 Dollars)

Component	Height Above Ground	Cost	Per
Levee	2 Feet	\$63	Linear Foot
	4 Feet	\$118	Linear Foot
	6 Feet	\$197	Linear Foot
Floodwall	2 Feet	\$145	Linear Foot
	4 Feet	\$212	Linear Foot
Levee Riprap	N/A	\$53	Cubic Yard
Interior Drainage System	N/A	\$7,200	Lump Sum
Closure (each)	N/A	\$125	Square Foot of Closure Area
Seeding of disturbed areas	N/A	\$0.10	Square Foot of Ground Area

3.4.6 Demolition



Demolition is tearing down a damaged home and either rebuilding a compliant home on the same property or moving to a home on another property, outside the regulatory floodplain. This retrofitting method may be the most practical of all those described in this guide when a home has sustained extensive damage, especially severe structural damage. Section 7.5 presents more detailed information on demolition.

Whether you intend to rebuild or move, you must tear down your damaged home and then restore the site. Site restoration usually involves filling in a basement, grading, and landscaping. As a result, you will need the services of a demolition contractor. The contractor will disconnect and cap all utility lines at the site and then raze the home with a bulldozer or other heavy equipment. If you decide to rebuild on the old site or somewhere else on the same property, your construction contractor may be able to do the demolition and site restoration work as part of the home construction.

Remember, all demolition, construction, and site restoration work must be done according to the regulatory requirements of your community. Permits may be required for all or part of this work. If you decide to rebuild on the site of your old home, you must rebuild in compliance with your community's floodplain management ordinance or law and other ordinances and codes, which means ensuring that the lowest floor of your new home is at or above the DFE. You can do this by elevating your new home on an extended foundation as described in Section 3.4.1 or on compacted fill dirt if your property is located in an A zone. If your property is located in a V zone, you must elevate your home on piles or columns. If you plan to build your home on an alternative building site outside the regulatory floodplain, a better approach is to build on that site, where you can use standard construction practices, including the construction of a basement. Remember, if you rebuild on the same site, within the regulatory floodplain, your community's floodplain management ordinance or law will not allow your new home to have a basement (as defined by the NFIP regulations) if it is located below the BFE.



NOTE

As discussed in Section 2.7, the cost of demolishing a substantially damaged home may be an eligible flood insurance claim under ICC coverage.



NOTE

If your property is in the SFHA and the local ordinance prohibits construction in the floodway or flood fringe, you cannot do mitigation reconstruction on the site.

The advantages and disadvantages of demolition vary depending on which of the following three options you choose:

1. rebuilding on the existing site
2. rebuilding on an alternative, flood-free site elsewhere on your property
3. moving to a home on another property, outside the regulatory floodplain

The advantages and disadvantages of option 1 are same as those listed in Table 3-1 for the elevation method. The advantages and disadvantages of options 2 and 3 are the same as those listed in Table 3-7 for the relocation method, with the following exceptions. If you choose option 2, you will avoid the need to buy another lot and dispose of your existing property.

If you decide to demolish your damaged home and rebuild somewhere on your existing property (option 1 or 2 above), your costs will include tearing down the damaged home, building the new home to the community’s specified elevation, reconnecting utility lines, and restoring the site around the new home. If you decide to move to a home outside the regulatory floodplain (option 3), your costs will be for tearing down the damaged home, buying or building a home elsewhere, capping and abandoning the old utility lines, and restoring the old site.

The cost of tearing a home down, which is not a complex or difficult job, will be almost entirely for the disposal of the resulting debris. This cost can vary widely, depending on the amount of debris and whether a dumping fee is required at the disposal site. The major costs associated with the demolition method will be for building or buying a home and will, therefore, depend on how and where you build or on the type of home you buy. Be sure to get a complete cost estimate before you begin a demolition project. Table 3-15 shows approximate costs for tearing down your home and rebuilding on the same site.

Table 3-15. Approximate Costs of Mitigation Reconstruction (2009 Dollars)









Construction Type	Elevated Foundation Type	Elevated Foundation Type	Cost (per square foot of house footprint)
Frame	Closed Foundation	2 to 4 Feet	\$110
		10 Feet	\$129
	Open Foundation	2 to 4 Feet	\$119
		10 Feet	\$125
Frame with Brick Veneer	Closed Foundation	2 to 4 Feet	\$126
		10 Feet	\$146
	Open Foundation	2 to 4 Feet	\$135
		10 Feet	\$141

3.5 Summary

To protect your home from flooding, you may be able to use one or more of the retrofitting methods described in this chapter. However, some retrofitting methods are probably inappropriate for your home and some may not be allowed by your State or community. Also, if the substantial improvement and substantial damage requirements do not apply to your home, you may be faced with decisions about the level of protection you are willing to pay for and the level of risk you are willing to accept. Table 3-16 provides a comparison of the relative costs of each of the retrofitting methods listed in this chapter based on home construction type and foundation type.

Chapter 4 will help you decide on a method—note that cost is not the only consideration when evaluating mitigation measures. Depending on your decision, you can move on to Chapter 5, 6, or 7 for a detailed look at your preferred method.

Table 3-16. Relative Costs of Various Retrofit Measures

Construction Type	Existing Foundation	Measure	Retrofit	Relative Cost
Frame, Masonry Veneer, or Masonry	Crawlspace or Basement	Wet Floodproofing 	Wet floodproof crawlspace to a height of 4 feet above LAG or wet floodproof unfinished basement to a height of 8 feet above basement floor	Lowest  Highest
Masonry Veneer or Masonry	Slab-on-Grade or Crawlspace	Dry Floodproofing 	Dry floodproof to a maximum height of 3 feet above LAG	
Frame, Masonry Veneer, or Masonry	Basement, Crawlspace, or Open Foundation	Levees and Floodwalls 	Levee constructed to 6 feet above grade or floodwall constructed to 4 feet above grade	
Frame, Masonry Veneer, or Masonry	Basement, Crawlspace, or Open Foundation	Elevation 	Elevate on continuous foundation walls or open foundation	
Frame, Masonry Veneer, or Masonry	Basement, Crawlspace, or Open Foundation	Relocation 	Elevate on continuous foundation walls or open foundation	
Frame, Masonry Veneer, or Masonry	Slab-on-Grade	Elevation 	Elevate on continuous foundation walls or open foundation	
Frame, Masonry Veneer, or Masonry	Slab-on-Grade	Relocation 	Elevate on continuous foundation walls or open foundation	
Frame, Masonry Veneer, or Masonry	Slab-on-Grade, Crawlspace, Basement, or Open Foundation	Demolition 	Demolish existing building and buying or building a home elsewhere	

4.0 Deciding Which Method Is Right for Your Home

4.1 Introduction

With the information from Chapters 2 and 3, you are ready to decide which retrofitting method is right for your home. Your decision will be based primarily on permit requirements, the technical limitations of the methods, and cost. Other considerations might include such things as the appearance of the home after retrofitting and any inconvenience resulting from retrofitting. Making a decision involves four steps:

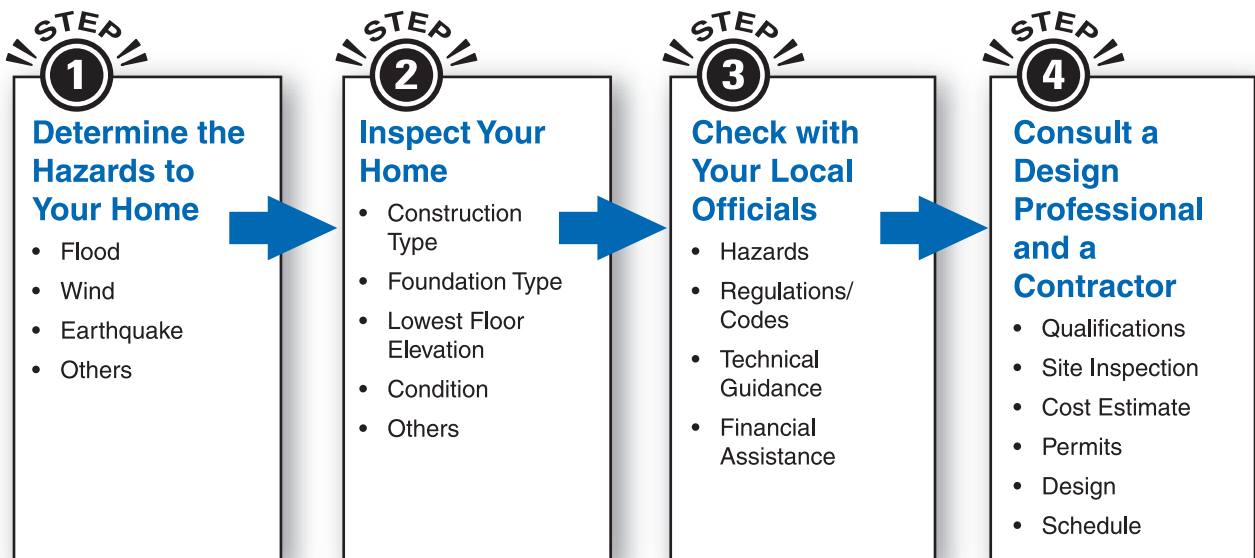

The four steps are described in the next section. At the end of this chapter you will find a retrofitting checklist that will help you work with local officials, design professionals, and retrofitting contractors. The checklist includes spaces where you can record the results of Steps 1 and 2, important questions you should ask, and decision-making matrices that will help you choose a retrofitting method. Before you go any further, you may want to make a copy of the checklist (see Section 4.3) so that you can begin filling it out.



NOTE

The results of Steps 1 and 2 will help your local official to advise you and will also be useful when you consult a design professional or retrofitting contractor.

4.2 Making Your Decision

4.2.1 Step 1 – Determine the Hazards to Your Home

If you are using this guide, it is probably because your home has been damaged by flooding or because you know that it is in a flood hazard area. Refer to Section 2.4 for descriptions of each of the hazards in the checklist. Information about flooding and other hazards in your area is available from local officials, as discussed later in Step 3. But if your home has been flooded, review what you already know. Look at the Step 1 section of the checklist. Answer as many of the questions as you can. Local officials, design professionals, and contractors can use the information you provide, along with the flood hazard information developed by FEMA and other agencies and organizations, to advise you about your retrofitting options.

You also need to be aware of other hazards, such as high winds (Figure 4-1), earthquakes (Figure 4-2), fires, landslides, and **tsunamis**. If your home is in an area subject to one or more of these hazards, your retrofitting project should take the additional hazards into account. For example, as discussed in Chapter 3, elevating a home may make it more susceptible to earthquakes. As a result, the foundation may need to be reinforced and the connections between the foundation, walls, and roof may need to be strengthened as part of the retrofitting project. Depending on the nature of the hazards and your choice of retrofitting methods, State and local regulations may require that additional changes be made to your home, beyond those necessary for flood protection. Your local officials can tell you if such requirements apply and can give you more information.



DEFINITION

A **tsunami** is a great sea wave produced by an undersea earth movement or volcanic eruption.

4.2.2 Step 2 – Inspect Your Home

The discussion in Chapter 3 may have prompted you to begin thinking about your home, specifically how it is constructed and the type of foundation it has. Before you check with your local officials or consult a design professional and contractor, you should inspect your home and fill out the section of the checklist for Step 2. Four characteristics of your home that are particularly important in retrofitting are construction type, foundation type, lowest floor elevation, and condition. (When you fill out the portion of the checklist concerning construction and foundation type, you may want to refer to the descriptions in Chapter 3.)

Construction Type

As explained in Chapter 3, the construction type for most homes will be frame, masonry veneer, masonry, modular, manufactured, or a combination of two or more of these types. The following generalizations can be made about the effect of construction type on retrofitting:

- The most appropriate elevation technique for frame homes, and manufactured homes

usually is to elevate on extended foundation walls or open foundations.

- A commonly used elevation technique for masonry homes usually is either (1) to extend the walls of the home upward and raise the lower floor inside or (2) abandon the lowest floor and move the living area to an existing or new upper floor.
- Frame homes, masonry veneer homes, and manufactured homes are easier to relocate than masonry homes.
- Masonry and masonry veneer homes are usually easier to dry floodproof than other types of homes, because masonry is a more flood damage-resistant material than the materials used in other types of homes.

Foundation Type

As explained in Chapter 3, most homes of the construction types listed above are built on a basement, crawlspace, slab-on-grade, or open foundation or on a combination of two or more of these types. The following generalizations can be made about the effect of foundation type on retrofitting:

- Homes on basement or crawlspace foundations are easier to elevate than slab-on-grade homes.
- Elevating homes on basement foundations normally involves elevating or relocating utility system components typically found in basements, such as furnaces and hot water heaters.
- Homes on basement foundations should not be dry floodproofed or protected by levees or floodwalls unless an engineering evaluation conducted by a design professional shows that it is safe to do so. This precaution is necessary because neither dry floodproofing nor the construction of levees or floodwalls prevents saturated soils from pressing on basement walls. This pressure, which is unequalized because water is not allowed to enter the basement, can damage basement walls or even cause them to fail.
- For some homes on basement foundations, the same type of engineering evaluation is a necessary part of a wet floodproofing project. If the home is in an area where saturated soils begin to press on basement walls before water enters the basement, the unequalized pressure may damage walls or cause them to fail. If wet floodproofing is to be used in this situation, the engineering evaluation must show that the basement walls can resist the expected pressure.



WARNING

If you are retrofitting a home that is being substantially improved or has been substantially damaged, your community's floodplain management ordinance or law will not allow you to have a basement below the BFE, as defined under the National Flood Insurance Program. The NFIP regulations define a basement as "any area of the building having its floor subgrade on all sides." If your home has such a basement, you will be required to fill it in as part of any elevation project. Note that the NFIP definition of basement does not include what is typically referred to as a "walkout-on-grade" basement, whose floor would be at or above adjacent grade on at least one side (see Section 2.4.1).

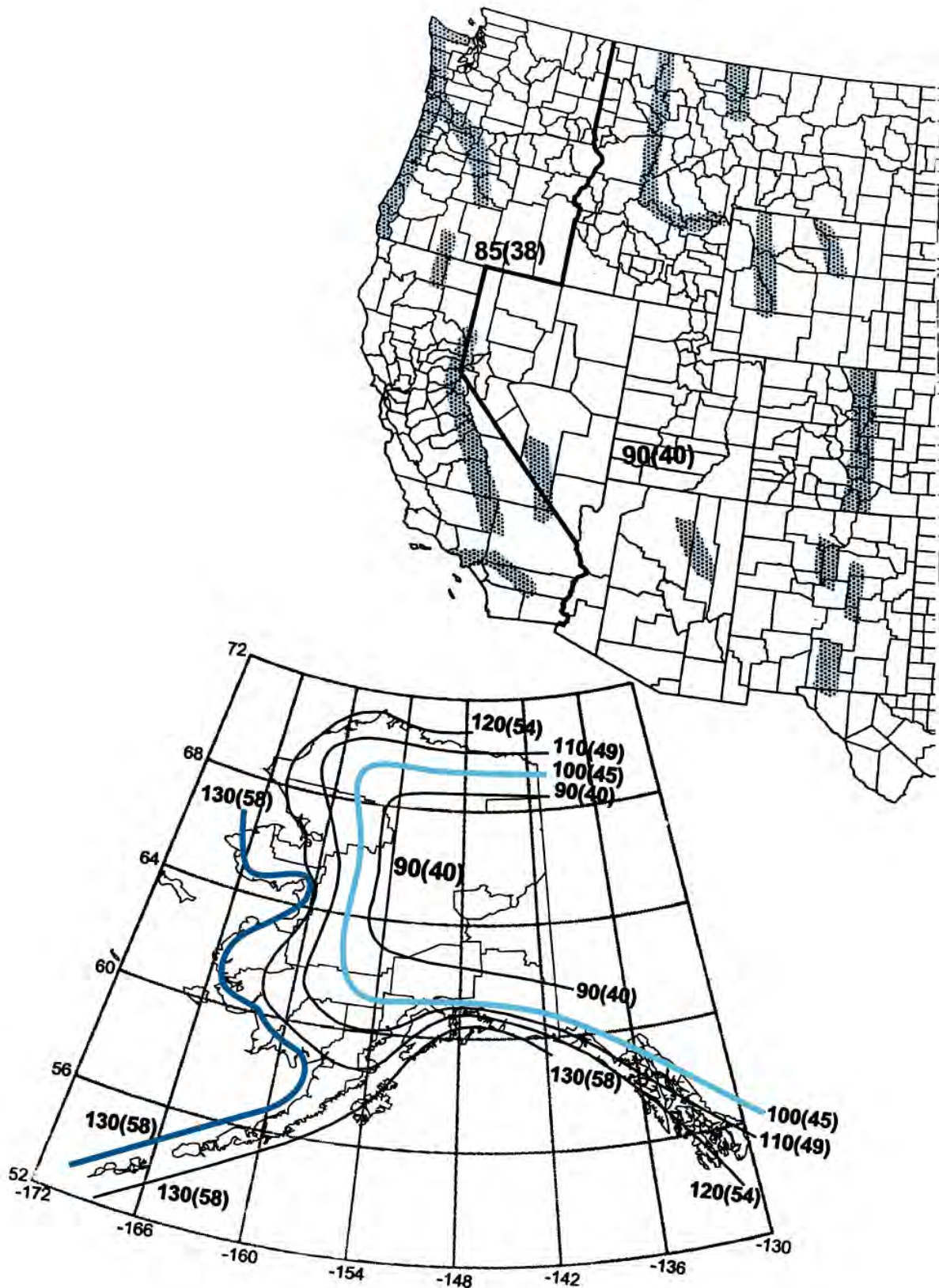
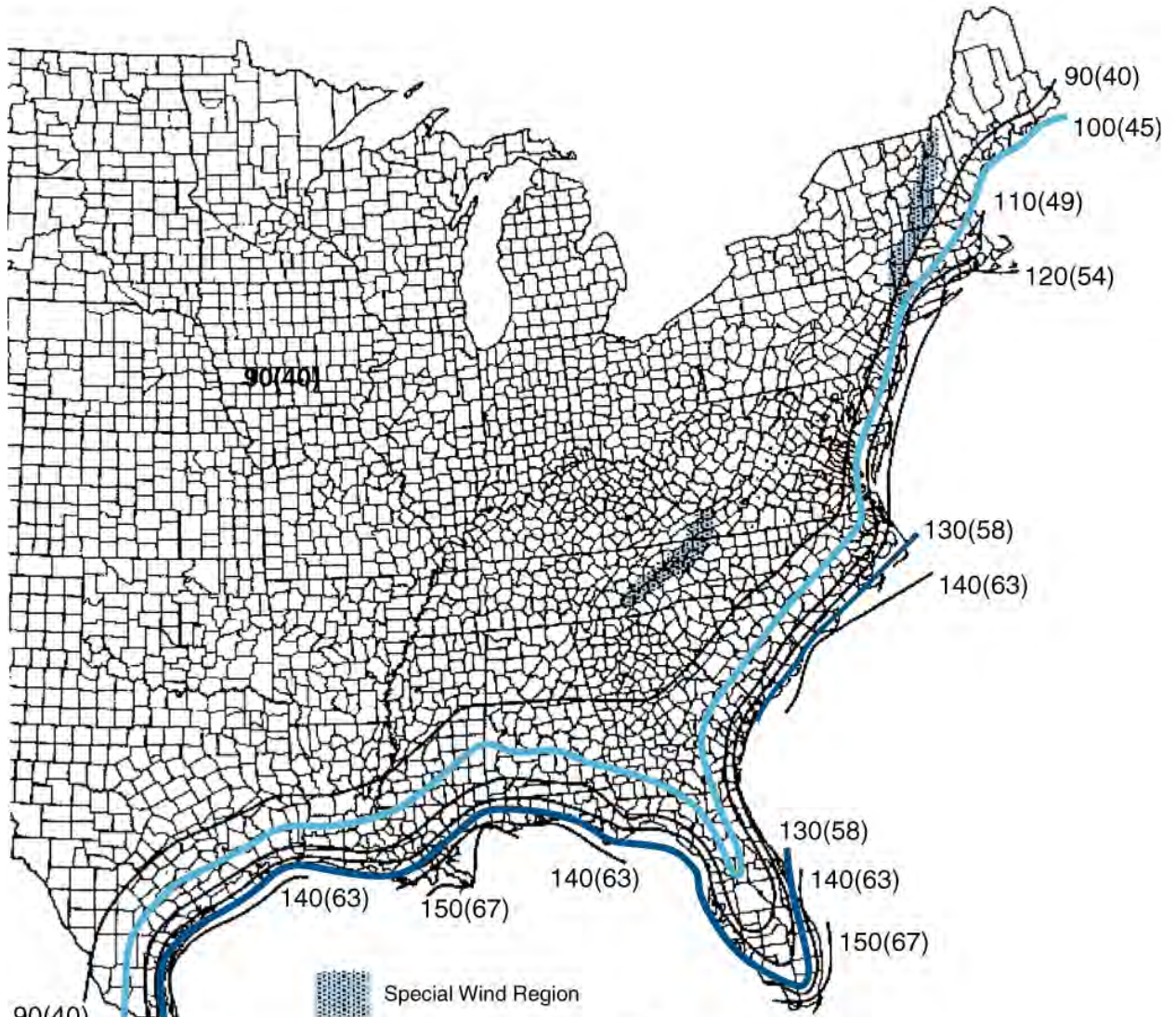



Figure 4-1. Peak gust wind speeds in the United States.



90(40)
100(45) 130(58)
110(49) 120(54)

 Special Wind Region

Location	V mph	(m/s)
Hawaii	105	(47)
Puerto Rico	145	(65)
Guam	170	(76)
Virgin Islands	145	(65)
American Samoa	125	(56)

Notes:

1. Values are nominal design 3-second gust wind speeds in miles per hour (m/s) at 33 ft (10 m) above ground for Exposure C category.
2. Linear interpolation between wind contours is permitted.
3. Islands and coastal areas outside the last contour shall use the last wind speed contour of the coastal area.
4. Mountainous terrain, gorges, ocean promontories, and special wind regions shall be examined for unusual wind conditions.

Source: *Minimum Design Loads for Buildings and Other Structures*, ASCE/SEI 7-05.
Used with permission of ASCE.

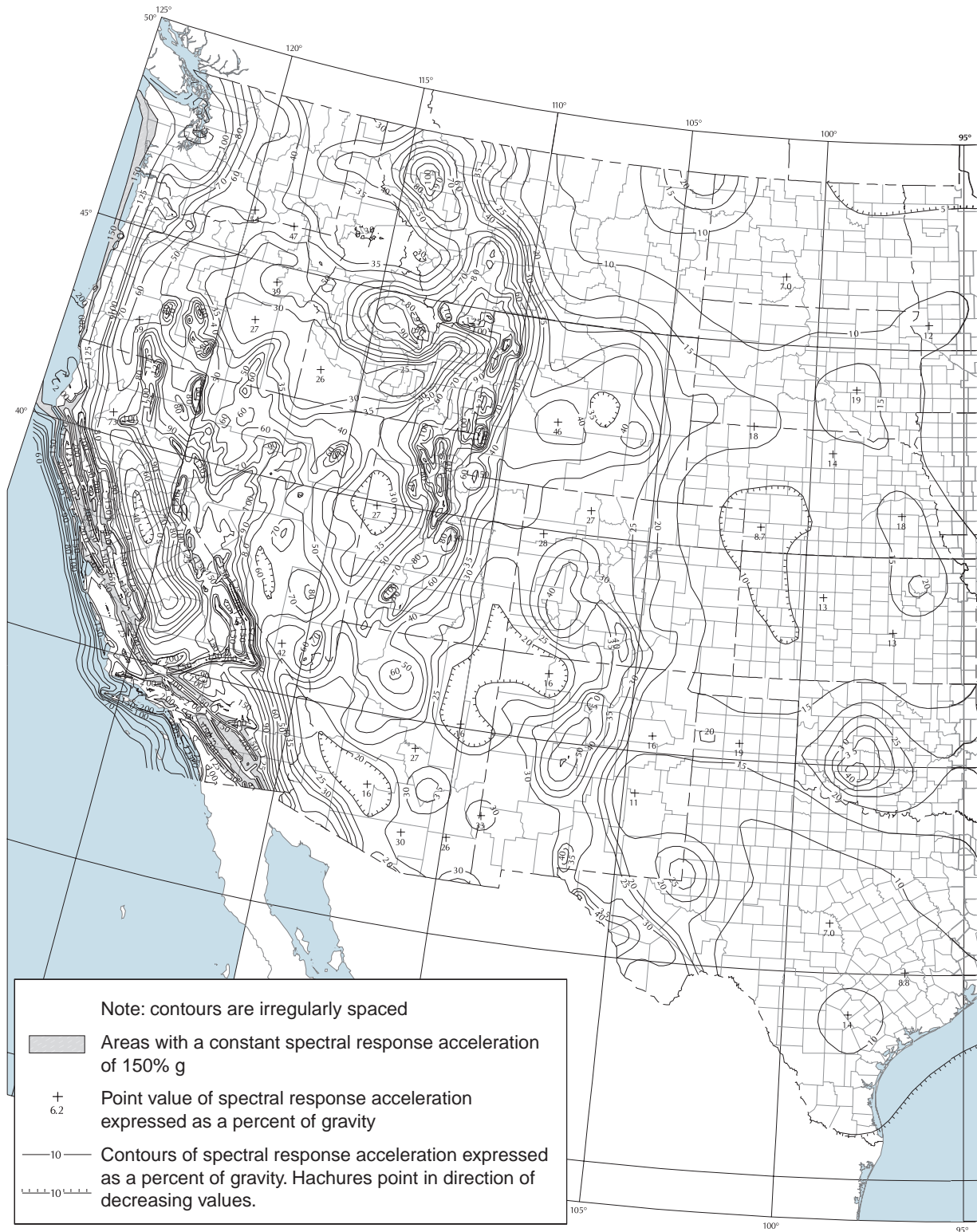

Source: *Minimum Design Loads for Buildings and Other Structures*, ASCE/SEI 7-05. Used with permission of ASCE.

Figure 4-2. Earthquake hazards in the United States

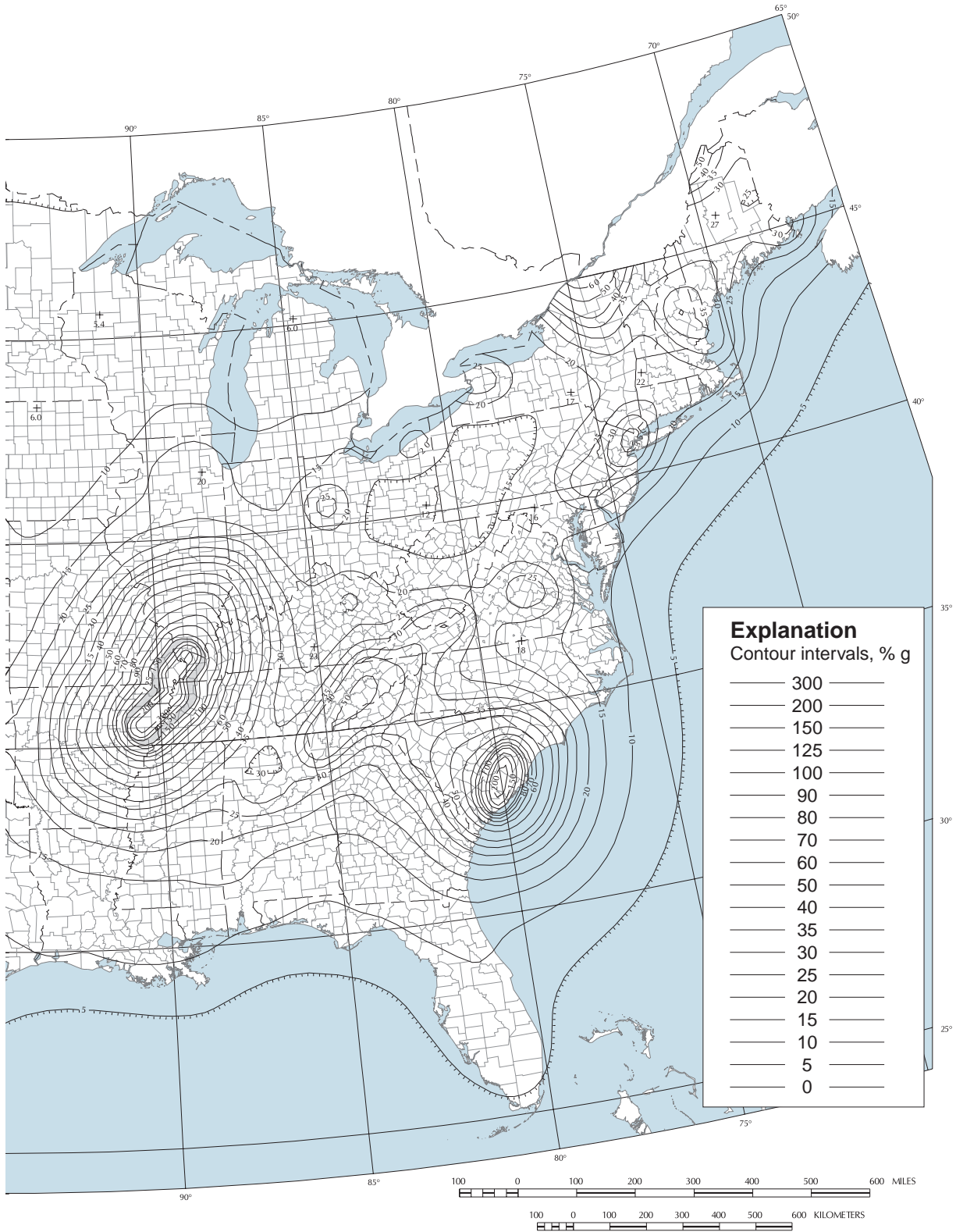

Lowest Floor Elevation

As noted in Chapter 3, the “lowest floor” of your home, as defined by your community’s floodplain management ordinance or law, is not necessarily the first or finished floor. For example, the lowest floor could be the floor of a basement or the floor of an attached garage. As shown in Figure 4-3, the location of your lowest floor can vary with foundation type. For homes that are to be elevated, wet floodproofed, or dry floodproofed, the difference between the elevation of the lowest floor and the design flood elevation (DFE) determines how high the home must be elevated or how high the wet or dry floodproofing protection must reach. In general, as the difference between the lowest floor elevation and the DFE increases, so does the cost of elevating, wet floodproofing, or dry floodproofing. This difference is particularly significant for dry floodproofing. As noted in Chapter 3, even masonry walls should not be dry floodproofed higher than 3 feet unless a structural evaluation by a design professional shows that it is safe to do so.

Figure 4-3. Differences between flood level and lowest floor in homes on crawlspace and basement foundations.

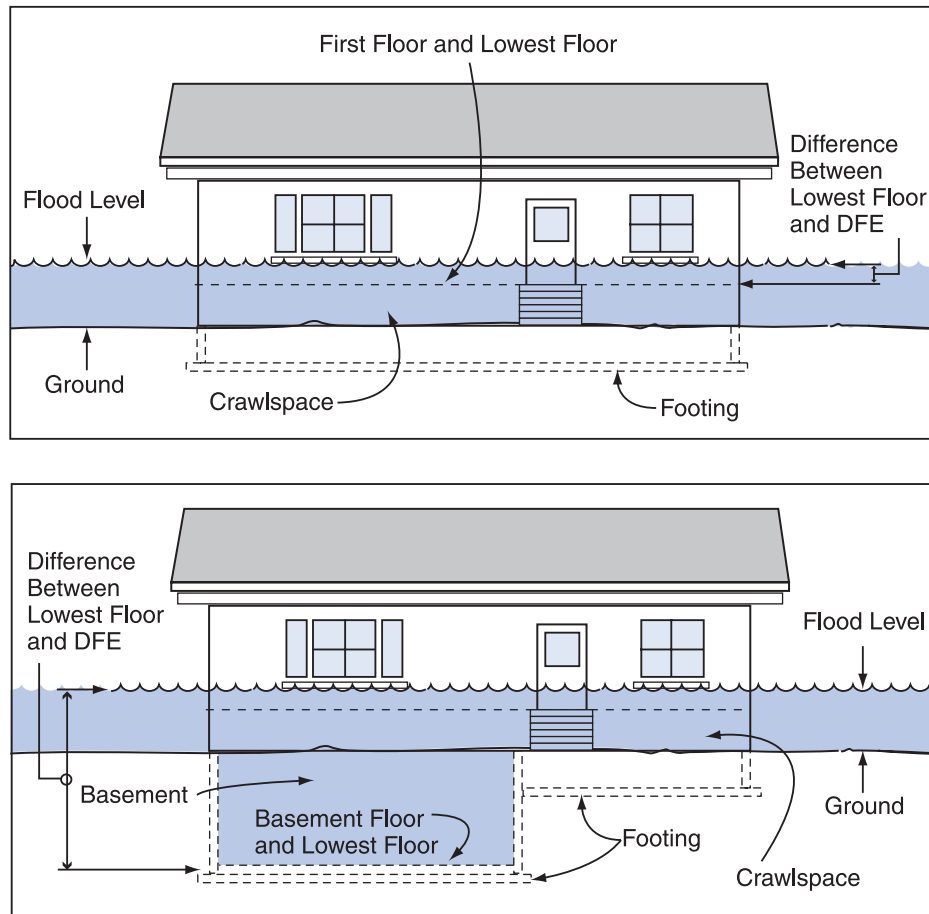

The elevation of your lowest floor can be established by a survey, which may be necessary as part of your retrofitting project. But even if you do not know your lowest floor elevation, you can estimate the difference between it and the DFE. If you haven’t yet decided on a DFE, don’t worry. Your conversations with your local officials, design professionals, and contractors will help you determine the level of flood protection you should provide. **Remember, if your home is being**

substantially improved or has been substantially damaged according to your community's floodplain management ordinance or law, your DFE must be at least equal to the BFE. As explained in Step 3, your local officials can tell you about this requirement.

Condition

Your design professional or contractor should conduct a detailed inspection of your home before beginning any retrofitting work. You can help by first conducting your own assessment of the condition of your home and recording any information you have about past or current damage. This information may also be helpful to community officials who advise you about floodplain management and building code requirements and appropriate retrofitting methods.

If your home has been damaged by a flood, hurricane or other high-wind event, earthquake, fire, or other disaster, make a note of the extent of the damage, when it occurred, and whether it was repaired (the checklist provided in Section 4.3 can be used to list these damages). If repairs were made, make a note of who made them and describe what was done. Any structural damage and repairs to walls, floors, foundations, and roofs is particularly important. You should also describe any damage resulting from other causes, such as foundation settlement, dry rot, and termite damage. Your goal is to give your design professional and contractor as much information as possible so that they can determine how the condition of your home will affect your choice of a retrofitting method.



NOTE

Professional termite exterminators will often perform free or low-cost inspections for termite damage.

Obtaining an Elevation Certificate

Elevation certificates are used to determine insurance premium rates under the NFIP. If your community participates in the NFIP, it must obtain the as built elevation of the lowest floor for all new or substantially improved structures in SFHAs. Your community may use FEMA's Elevation Certificates to keep track of lowest floor elevations for buildings that are elevated. Communities that participate in the NFIP Community Rating System are required to obtain and maintain Elevation Certificates. The Elevation Certificate may be used to support a **Letter of Map Amendment (LOMA)**.



DEFINITION

Occasionally, a small area is inadvertently shown to be within the SFHA on a FIRM, even though the ground is at or above the BFE. If this occurs, an individual property owner may submit survey information to FEMA and request that FEMA issue a document that officially removes a property from the SFHA, called a **Letter of Map Amendment**.

An elevation certificate provides information about a specific property, including:

- Property information, including address, building use, and foundation information
- FIRM information, including map number and BFE
- Building elevation information determined by a survey
- Certification by an engineer, architect, or surveyor
- Photographs of the building

Elevation certificates must be completed by a land surveyor, engineer, or architect who is licensed in your State to perform surveys. Instructions on completing the elevation certificate and the form itself may be found on the FEMA website at <http://www.fema.gov/pdf/nfip/elv-cert.pdf>.

Other Considerations

In addition to construction type, foundation type, and lowest floor elevation, you should make note of interior and exterior service equipment that must be protected as part of your retrofitting project. Interior service equipment must be protected if you elevate or wet floodproof your home. This equipment includes furnaces, heating and air conditioning ductwork, hot water heaters, large appliances, and electrical system components such as service panels, outlets, and switches. Exterior service equipment must be protected if you elevate, wet floodproof, or dry floodproof and, in some situations, if you build a levee or floodwall. This equipment includes air conditioning and heat pump compressors, and electric and gas meters.

In a home that is dry floodproofed, all openings below the DFE should be sealed. These openings may include doors and windows as well as openings for water pipes, gas and electric lines, dryer vents, and sump pump discharge pipes. In a home that is wet floodproofed, dry floodproofed, or protected by a levee or floodwall, backflow valves must be installed on all water and sewer lines with openings below the DFE. These valves prevent floodwaters and wastewaters from backing up into your home. Chapter 8 describes how to protect interior and exterior service equipment.



NOTE

Elevation of electric and gas meters is typically controlled by the utility company.



WARNING

It may not be possible to wet floodproof or dry floodproof to the BFE.

4.2.3 Step 3 – Check with Your Local Officials

This is a particularly important step. While you can obtain information from your FIS and your FIRM online (Chapter 2 discusses how to obtain FIRMs online), your local officials can help you to interpret that information. They will have hard copies of the FIS and FIRM for your community published by FEMA. Your officials will be able to tell you whether your home is in your community's regulatory floodplain and, if so, the BFE at the location of your home. They may also have information about flood conditions near your home, including flow velocity, the potential for wave action and debris flow, rates of rise and fall, warning time, and duration of inundation.

Local officials will inform you of Federal, State, and local regulations, codes, and other requirements that can determine what retrofitting methods you will be allowed to use and how changes can be made to your home. They can also tell you about Federal, State, and local programs that provide financial assistance for homeowner retrofitting projects, and they can help you determine whether you are eligible for such assistance. With the information you recorded in Steps 1 and 2, local officials may also be able to advise you about the most appropriate retrofitting method for your home. The officials you need to talk to will depend on how your community has assigned responsibilities for floodplain management and construction permitting. If you do not know who has these responsibilities in your community, you should begin with an official such as a city clerk, mayor, or county administrator.

Remember, that if your property is 50 years or more in age and you are receiving Federal financial assistance for your retrofitting project, the Federal agency providing the assistance must first satisfy Federal historic preservation compliance requirements. Your local officials may not be aware of these requirements if they do not normally deal with federally assisted projects. Should historic preservation compliance be triggered, the Federal agency will need to consult with your State Historic Preservation Officer (see Appendix E). It is important to remember that any compliance review must be completed before retrofitting work is initiated or the Federal assistance could be jeopardized.

When you talk to your local officials, be sure to do the following:

- Bring this guide with you.
- Bring your completed retrofitting checklist.
- Discuss what you already know about your home and the hazards that affect it.
- Work through the points listed in the section of the checklist for Step 3.
- Ask any other questions you may have.
- Work through the decision-making matrix provided in Section 4.4 with the official. Use the matrix that applies to your situation:



NOTE

Be sure to ask local officials about State or local freeboard requirements that may apply to your retrofitting project.

Substantial Improvement/Substantial Damage or NOT Substantial Improvement/NOT Substantial Damage.

- Take notes about everything you discuss.

Remember that your goal is to find out what you can legally do to retrofit your home, identify the requirements you must comply with throughout the retrofitting process, and eliminate retrofitting methods that cannot be applied to your home or do not meet your needs. You may find that the restrictions and requirements of Federal, State, and local regulations will eliminate some retrofitting methods from consideration. Ultimately, your decision will be based on technical limitations of the methods, cost, and other considerations, such as the effect that retrofitting will have on the appearance of your home. The decision-making matrices will help guide you through this process.

Your next step, whether you have chosen one method or are considering two or more, is to consult a properly licensed, bonded, and insured design professional and retrofitting contractor.

4.2.4 Step 4 – Consult a Design Professional and Retrofitting Contractor

To complete this step, you will need to know what types of services are required for your retrofitting project and how to evaluate and select design professionals and contractors.

You will probably need the services of a contractor regardless of the retrofitting method you select. The type of contractor you hire will depend on the method. You will probably also need to consult a design professional, such as an architect or a structural engineer. Alternatively, you can hire a general contractor who will arrange for all the necessary services, including those of a design professional. Table 4-1 shows the types of design professionals and contractors that may be required for each of the retrofitting methods.



WARNING

Areas recovering from floods are often prime targets for less-than-honest business activities. Here are some pointers that can help you avoid problems:

Check with your local Better Business Bureau, consumer protection agency, or licensing authorities before you hire a contractor.

Beware of “special deals” offered after a disaster by contractors you don’t know.

Beware of unknown contractors who offer to use your home as a “model home” for their work.

Do not sign any contract under pressure by a salesperson. Federal law requires a 3-day cooling-off period for unsolicited door-to-door sales of more than \$25.

Beware if you are asked to pay cash on the spot instead of with a check made out to the name of a business.

Ask contractors for references. A reputable contractor should be able to give you a list of past clients in your area who can comment on the quality of the contractor’s work.

Knowing the types of services required for your retrofitting project is important, but so is making sure that your design professional and contractor are reputable and competent.

If you have used a licensed design professional and a licensed contractor in the past and were satisfied with the work, you might consider using them again. Even if they do not provide the types of services you now need, they may be able to recommend someone who can. Otherwise, you can check the telephone directory or contact the professional association that represents the types of specialists you are looking for. Appendix F contains a list of the addresses and telephone numbers of several of these associations. They can usually give you a list of members in your area who specialize in the type of work you need.



NOTE

In addition to meeting the minimum requirements laid out in your local floodplain ordinance, any retrofit activities should comply with the current building code. Talk to your design professional about applicable codes and standards.

Before you hire a design professional or a contractor, you should check with your local Better Business Bureau, consumer protection agency, or licensing authorities. These organizations can tell you whether there have been any complaints about the quality of the design professional's or contractor's past work, including whether the work was completed on time.

Next, you will need to meet with the design professional, and contractor to discuss your project. At the meeting, be sure you do the following:

- Provide the information you collected in Steps 1, 2, and 3.
- Ask the questions listed on the retrofitting checklist at the end of this chapter, as well as any others you may have.
- Verify that the design professional is licensed and registered in the State in which the work will be done.
- Verify that the contractor is licensed, bonded, and insured as required by State and local laws.
- Ask for proof of insurance. If the design professional or contractor does not have disability and worker's compensation insurance, you may be liable for accidents that occur on your property.
- Ask for references. Reputable design professionals and contractors should be willing to give you the names of previous customers. Call some of them and ask how satisfied they were with the work. Ask if they would hire the design professional or contractor again.
- If you are trying to decide between two or more retrofitting methods, discuss your preferences and ask for more information.

Table 4-1. Requirements for Design Professional and Contractor Services







Method	Need for Design Professional and/or Contractor	Primary Services
Elevation 	Design Professional	Evaluating the condition, stability, and strength of the existing foundation to determine whether it can support the increased load of the elevated home, including any wind and seismic loads or designing a new foundation
	Contractor: Home Elevation Contractor	Disconnecting utilities, jacking the home up, increasing the height of the foundation or building a new foundation, and connecting utilities
Wet Floodproofing 	Design Professional	Designing any necessary replacements of vulnerable structural materials and relocated utility systems
	Contractor: General Construction Contractor	Replacing vulnerable structural and finish materials below the DFE with flood damage-resistant materials, raising utilities and appliances to a location above the DFE, and installing openings required to allow the entry of floodwaters
Relocation 	Design Professional	Designing any new building, foundation, and site improvements that may be required, such as new utility systems
	Contractor: Home Moving Contractor	Jacking the home up, moving it to the new site, and installing it on the new foundation
	Contractor: General Construction Contractor	Preparing the new site (including grading, foundation construction, and utilities) and cleaning up the old site (including demolition)
Dry Floodproofing 	Design Professional	For masonry walls to be dry floodproofed, evaluating the condition, stability, and strength of the existing walls to verify whether they can withstand the pressure from floodwaters at the DFE; designing or selecting flood shields for doors or other openings
	Contractor: General Construction Contractor	Applying waterproof sealants and membranes, installing flood shields over openings below the DFE, installing backflow valves in sewer and water lines, and, if necessary, bracing or modifying walls so that they can withstand the pressure from floodwaters at the DFE
Levees and Floodwalls 	Design Professional	Assessing the adequacy of soils at the site, preparing the engineering design to ensure that the levee or floodwall, including any closures required, will be structurally stable under the expected flood loads and will be able to resist erosion, scour, and seepage
	Contractor: General Construction Contractor	Constructing the levee or floodwall

Table 4-1. Requirements for Design Professional and Contractor Services (continued)

Method	Need for Design Professional and/or Contractor	Primary Services
Demolition 	Design Professional	Designing any new building, foundation, and site improvements that may be required, such as new utility systems
	Contractor: Demolition Contractor	Disconnecting and capping utility lines, tearing down the damaged home, hauling away debris, and cleaning up the old site
	Contractor: General Construction Contractor	Building the new home on the new site; may also be able to do all demolition work

Any design professional or contractor you hire will need to conduct a site visit to inspect your home and determine how the work should be carried out. During the site visit, you should expect your design professional or contractor to assess the structural condition of your home and determine what changes will be required by the retrofitting method you choose. If you agree on a method and decide to proceed with the project, be sure to do the following:

- Get a written, signed, and dated estimate. It should cover everything you expect to be done. (Some design professionals and contractors will charge a fee to prepare the estimate.)
- Get signed and stamped building plans that show details of the proposed retrofitting measure.
- Decide whether you, the design professional, or contractor will obtain the necessary permits.
- Ask for a warranty or guarantee. Any warranty or guarantee from the design professional or contractor should be written into the contract. The contract should clearly state the terms of the warranty or guarantee, who is responsible for honoring it (such as a manufacturer or the contractor), and how long it will remain valid.
- Get a written contract. It should be complete and clearly state all work to be done, the estimated cost, the payment schedule, and the expected start and completion dates for the work.



WARNING

Do not sign completion papers or make the final payment until all work is completed to your satisfaction and inspected by your community if a building permit was issued.

Note that, if the project was funded through a FEMA HMA grant, work cannot proceed until final approvals are obtained from FEMA.

4.3 Retrofitting Checklist

Use this checklist when you follow the four steps described in this chapter. The information you record here will help you work with local officials, design professionals, and contractors. Use the decision-making matrices that follow this checklist to decide which retrofitting method is right for your home.

Step 1 – Determine the Hazards to Your Home

1. How long have you lived in your home? ___ years
2. Was your home ever flooded during that time? ___ yes ___ no
(If your answer is yes, go to question 3; if your answer is no, go to question 14.)
3. How many times has your home been flooded? _____
4. What were the dates of flooding?

Flood #1 _____ Flood #4 _____
Flood #2 _____ Flood #5 _____
Flood #3 _____

For each flood, answer questions 5 through 13 as best you can.

5. To your knowledge, were frequencies assigned to any of the floods (e.g., 2-percent annual chance flood, 1-percent annual chance flood)? If so, what were they?

Flood #1 _____
Flood #2 _____
Flood #3 _____
Flood #4 _____
Flood #5 _____

6. How high did the floodwaters rise in your home? (If you can, state the height of the water above the lowest floor, including the basement floor.)

Flood #1 _____
Flood #2 _____

Flood #3 _____

Flood #4 _____

Flood #5 _____

7. About how long did your home remain flooded? (You can give your answer in days, weeks, or months, as appropriate.)

Flood #1 _____

Flood #2 _____

Flood #3 _____

Flood #4 _____

Flood #5 _____

8. Did you have any warning before your home was flooded? If so, how much warning? (You can give your answer in days or hours as appropriate.)

Flood #1 _____ No Warning _____ Warning _____ Days / Hours

Source of warning (news report, local officials, firsthand observation): _____

Flood #2 _____ No Warning _____ Warning _____ Days / Hours

Source of warning (news report, local officials, firsthand observation): _____

Flood #3 _____ No Warning _____ Warning _____ Days / Hours

Source of warning (news report, local officials, firsthand observation): _____

Flood #4 _____ No Warning _____ Warning _____ Days / Hours

Source of warning (news report, local officials, firsthand observation): _____

4 DECIDING WHICH METHOD IS RIGHT FOR YOUR HOME

Flood #5 _____ No Warning _____ Warning _____ Days / Hours

Source of warning (news report, local officials, firsthand observation): _____

9. Did the floodwaters cause scour and/or erosion around your home or elsewhere on your lot? If so, describe the effects.

Flood #1 ___ No Erosion/Scour Occurred ___ Erosion/Scour Occurred

Description _____

Flood #2 ___ No Erosion/Scour Occurred ___ Erosion/Scour Occurred

Description _____

Flood #3 ___ No Erosion/Scour Occurred ___ Erosion/Scour Occurred

Description _____

Flood #4 ___ No Erosion/Scour Occurred ___ Erosion/Scour Occurred

Description _____

Flood #5 ___ No Erosion/Scour Occurred ___ Erosion/Scour Occurred

Description _____

10. Was your home damaged by wave action or the impact of ice or other floodborne debris? If so, describe the damage.

Flood #1 ___ No Waves or Debris ___ Waves ___ Debris

Description of Damage _____

Flood #2 ___ No Waves or Debris ___ Waves ___ Debris

Description of Damage _____

Flood #3 ___ No Waves or Debris ___ Waves ___ Debris

Description of Damage _____

Flood #4 ___ No Waves or Debris ___ Waves ___ Debris

Description of Damage _____

Flood #5 ___ No Waves or Debris ___ Waves ___ Debris

Description of Damage _____

11. How difficult and/or expensive was cleaning up after the floodwaters receded? (If you can, describe what you had to do to clean up both inside your home and around your lot, how long the cleanup took, and how much you spent on cleanup.)

Flood #1 Cleanup Description _____

_____ Cost \$_____ Time _____

Flood #2 Cleanup Description _____

_____ Cost \$_____ Time _____

Flood #3 Cleanup Description _____

_____ Cost \$_____ Time _____

Flood #4 Cleanup Description _____

_____ Cost \$_____ Time _____

4 DECIDING WHICH METHOD IS RIGHT FOR YOUR HOME

Flood #5 Cleanup Description _____
_____ Cost \$ _____ Time _____

12. What was the total cost to repair all flood damage, not including the cleanup costs listed above?

Flood #1 \$ _____ Flood #4 \$ _____
Flood #2 \$ _____ Flood #5 \$ _____
Flood #3 \$ _____

13. What was the total value of all home contents (furnishings, belongings, etc.) damaged by flooding?

Flood #1 \$ _____ Flood #4 \$ _____
Flood #2 \$ _____ Flood #5 \$ _____
Flood #3 \$ _____

14. Is your home either in or near one of the shaded areas on the wind hazard map in Figure 4-1? ___ yes ___ no

15. Has your home ever been damaged by a hurricane or other high-wind event? ___ yes ___ no. If your answer is yes, note how many times and describe both the damage and the repairs made.

16. Is your home either in or near one of the shaded areas on the earthquake hazard map in Figure 4-2? ___ yes ___ no

17. Has your home ever been damaged by an earthquake? ___ yes ___ no. If your answer is yes, note how many times and describe both the damage and the repairs made.

18. Has your home ever been damaged by other hazard events, such as fires or landslides? ___ yes ___ no. If your answer is yes, note how many times and describe both the damage and the repairs made.

Step 2 – Inspect Your Home

Provide as much of the following information as you can about your home.

1. When was your home built? ___
2. Construction type (see Section 3.3.1; check all that apply): ___ frame ___ masonry veneer ___ masonry ___ manufactured home
3. Foundation type (see Section 3.3.2; check all that apply):
 ___ basement (subgrade on all sides) ___ walkout-on-grade basement ___ crawlspace
 ___ slab-on-grade ___ piers ___ posts/columns ___ piles

4 DECIDING WHICH METHOD IS RIGHT FOR YOUR HOME

4. Describe any other damage and repairs or other additions to your home other than those you described in Step 1. Other damages would include foundation settlement, dry rot, and termite damage.

To answer questions 5 through 9, you will need to have at least a rough idea of the DFE for your retrofitting project. If you don't have enough information to answer these questions now, go to Step 3 and determine your DFE when you talk with your local official(s).

5. Approximate difference between elevation of lowest floor (including basement) and design flood elevation (DFE) (see Figure 4-3): _____ feet
6. Interior utilities below the DFE (check all that apply): ___ furnace ___ ductwork
___ hot water heater ___ electrical panel ___ electrical outlets ___ electrical switches
___ baseboard heaters ___ sump pumps ___ fuel tanks other _____
7. Exterior utilities below the DFE (check all that apply): ___ air conditioning /heat pump
compressor ___ electric meter ___ fuel tank ___ septic tank ___ well ___ gas meter
other _____
8. Major appliances below the DFE (check all that apply): ___ washer ___ dryer
___ refrigerator ___ freezer other _____
9. How many drains (such as sink, tub, and floor drains) and toilets are below the DFE? _____

Step 3 – Check with Your Local Officials

When you meet with your local official(s), be sure to discuss the issues below. Also, make note of the information you receive from the local officials. (You may find that you will need to talk with more than one person to get all the information you need.)

1. Explain your retrofitting needs, go over the information you recorded in Steps 1 and 2, and discuss any preferences you may have regarding the retrofitting methods described in Chapter 3.
2. Provide the official with photographs of your home and a copy of a plat map that shows the dimensions of your lot and the location of your home. If you do not have a plat map, ask how you can get one.
3. Ask whether your home is in the regulatory floodplain. If the answer is yes, ask what the BFE is at your home and whether your home is in the floodway or Coastal High Hazard Area (V zone). Ask whether any restudies or revisions are underway that might provide updated flood hazard information for the area where your home is located. Also, ask for additional flood hazard information concerning characteristics such as flow velocity, the potential for wave action and debris flow, rates of rise and fall, warning time, and duration of inundation. This additional information may be useful to your design professional.
4. Ask whether your home is subject to your community's regulatory requirements concerning substantially damaged structures or if the retrofitting measure you are considering would subject your home to substantial improvement requirements. (See the definitions of substantial improvement and substantial damage in Sections 2.6 and 3.2.1.)
5. Ask whether your home is subject to high winds, earthquakes, and other hazards, such as wildfires. Refer to the maps in Figures 4-1 and 4-2.
6. Ask whether your State and/or community enforces building codes or other regulations that could affect your retrofitting decision, including any floodplain management regulations more stringent than those required by the NFIP. For example, ask whether the State or community requires freeboard for flood protection measures.
7. In your discussion of building codes, ask whether retrofitting will require that you upgrade other components of your home (such as electrical and plumbing systems) to meet current code requirements.
8. Ask about the types of permits and fees that may be required in connection with the retrofitting methods you are considering.
9. Ask whether the official is aware of any Federal, State, or local historic preservation regulations that may affect your property. If necessary, follow up by contacting your State Historic Preservation Office (see Appendix E) to be sure that your retrofitting project is in compliance with all preservation laws.
10. Ask about Federal, State, and local programs that provide financial assistance for certain types of homeowner flood protection retrofitting projects. Ask whether you are eligible for assistance.

11. Go through the appropriate decision-making matrix (see Section 4.4) with the official and discuss any questions you may have about the advantages and disadvantages of the alternative retrofitting methods.
12. Ask for any guidance that local officials can provide to help you find a good contractor or design professional.

Step 4 – Consult a Design Professional and Retrofitting Contractor

Initial Meeting

1. Explain your retrofitting needs; go over the information you recorded in Steps 1 and 2; discuss the results of your meeting with your local official(s), including the decision-making matrix; and discuss any preferences you may have regarding retrofitting methods you selected in Step 3.
2. Verify that the design professional is licensed and registered in the State where the work will be done.
3. Verify that the contractor is licensed, bonded, and insured required by State and local laws.
4. Ask for references and proof of proper bonds and insurance, including disability and workers' compensation.
5. Decide whether you, the design professional, or the contractor will be responsible for obtaining and managing the work of subcontractors and for obtaining all permits required by State and local agencies.
6. Schedule a site visit.

Site Visit

1. Ask the design professional or contractor to tell you about any characteristics of your home or lot that would affect your selection of a retrofitting method.
2. Once you decide on a retrofitting method, ask for a written estimate of the project cost and schedule.

Contract

1. If you are satisfied with the cost estimate and schedule, get a written, signed, and dated contract that describes the work to be done and states the estimated cost, the payment schedule, and the start and completion dates of the work.
2. Ask whether the contractor will provide a warranty or guarantee for the work performed.

Any warranty or guarantee should be written into the contract. The contract should state the terms of the warranty or guarantee, who is responsible for honoring it, and how long it will remain valid.

Notes

4.4 Decision-Making Matrices





4.4.1 Condition: Substantial Improvement /Substantial Damage

If your home either is being substantially improved or has been substantially damaged, the NFIP regulations limit your choice of retrofitting methods to elevation, relocation, or demolition. Regulations, ordinances, or laws established by other agencies and organizations may further limit your choice. Also, you may have already decided that one or more methods is not suitable or will not meet your needs. This matrix (Table 4-2) can help you decide which retrofitting method best meets your needs if your home is being substantially improved or has been substantially damaged. You may need guidance when using the matrix, so take it with you when you meet with local officials, design professionals, and contractors.

The first step in using the matrix is to identify any methods eliminated by regulations or by your own needs. Mark each eliminated method by placing an “X” in the box directly below the name of the method (on the line labeled “Prohibited by Federal, State, or Local Regulations or Eliminated by Homeowner”). An “X” in this row means that the method will not be considered in your decision.

The next step is to evaluate the remaining methods (those without an “X” under their names). Your evaluation will be based on the factors listed on the left-hand side of the matrix. (The factors are explained below the matrix.) For each evaluation factor under each method, discuss your concerns with your local official, design professional, and contractor. If your concerns cannot be resolved, place an “X” in the appropriate box. For example, if you decide that you would not be satisfied with the appearance of your home if it were elevated on extended foundation walls, you would place an “X” in the box on the *Appearance* line under the heading *Elevation on Extended Foundation Walls*. After you have worked through the entire matrix, add the number of “Xs” under each method and show the sum on the *Total “Xs”* line. The method with the lowest total is the one that best meets your requirements.

Table 4-2. Retrofitting Methods for Substantially Improved or Substantially Damaged Homes

Retrofitting Methods Substantially Improved or Substantially Damaged Homes					
Evaluation Factors	Elevation ¹			Relocation	Demolition
	Elevation on Extended Foundation Walls	Elevation on Open Foundation	New Living Area over Abandoned First Floor		
					
Prohibited by Federal, State, or Local Regulations or Eliminated by Homeowner					
Appearance					
Cost					
Accessibility					
Code-Required Upgrades					
Human Intervention					
Other					
Total "Xs"					

1. Note that if you elevate a substantially improved or substantially damaged home, you can still wet floodproof an enclosed area under the home below the BFE, provided that area is only used for parking, building access, or storage.

Evaluation Factors

Federal, State, and Local Restrictions – Federal, State, and local regulations may restrict a homeowner's choice of retrofitting measures. Such regulations may include State and local building codes, floodplain management ordinances or laws, zoning ordinances, Federal regulations concerning the alteration of buildings classified as historic structures, deed restrictions, and the covenants of homeowners' associations. The homeowner and the homeowner's design professional or contractor should check with community officials to determine whether any such restrictions apply.

Appearance – The final appearance of a home and property after retrofitting will depend largely on the retrofitting method used and the DFE. For example, elevating a home several feet will change its appearance more than elevating it only 1 or 2 feet, and a home elevated on an open foundation will not look the same as a home elevated on extended foundation walls. However, a change in appearance will not necessarily be a change for the worse (see photographs in Chapter 3). The homeowner should discuss the potential effects of each method with local officials and with the design professional or contractor.

Cost – The cost of retrofitting will depend largely on the retrofitting method used and the DFE. For some methods, the construction type (frame, masonry, etc.) and foundation type (crawl space, slab, etc.) will also affect the cost. In general, costs will increase as the DFE increases, but there may be tradeoffs between alternative methods.

Accessibility – Accessibility refers to how easy or difficult it is to routinely reach and enter the home after the retrofitting project is completed. The retrofitting methods described in this guide affect accessibility in different ways. For example, elevating a home will usually require the addition of stairs, which may be unacceptable to some homeowners. The effect of relocation on accessibility will depend on the location and configuration of the new site.

Code-Required Upgrades – State and local regulations may require that a retrofitted home be upgraded to meet current code requirements that were not in effect when the home was built. Portions of the electrical, plumbing, and HVAC systems could be affected. For example, the electrical panel might have to be upgraded from fuses to circuit breakers. These changes are required for the safety of the homeowner. Other possible code-required upgrades include those for increased energy efficiency. Any required upgrade can add to the scope and cost of the retrofitting project. The homeowner and the homeowner’s design professional or contractor should check with community officials to determine whether such regulations apply.

Human Intervention – For retrofitting methods that require human intervention, homeowners must be willing, able, and prepared to take the necessary action, such as operating a closure mechanism in a floodwall or placing flood barriers across the doors of a dry floodproofed home. Also, the homeowner must always have adequate warning of a coming flood and must be at home or near enough to be able to reach the home and take the necessary action before floodwaters arrive. If these conditions cannot be met, retrofitting methods that require human intervention should be eliminated from consideration.

Other – Homeowners may need to consider other factors, such as the availability of Federal, State, and local financial assistance; the likelihood of future flooding vs. the temporary inconvenience and cost of retrofitting; the amount of time required to complete the retrofitting project; and the need to move out of the home during construction (including the availability and cost of alternative housing).

4.4.2 Condition: NOT Substantial Improvement/NOT Substantial Damage









Use the matrix in Table 4-3 if your home is NOT being substantially improved or has NOT been substantially damaged. In this case, the NFIP regulations do not prohibit your use of any of the methods described in this guide. However, regulations, ordinances, or laws established by State or other local agencies and organizations may prohibit one or more of the methods. Also, you may have already decided that one or more methods will not meet your needs.

This matrix can help you decide which retrofitting method best meets your needs. You may need guidance when using the matrix, so take it with you when you meet with local officials, design professionals, and contractors. The first step in using the matrix is to identify any methods eliminated by regulations or by your own needs. Mark each eliminated method by placing an

“X” in the box directly below the name of the method (on the line labeled “Prohibited by Federal, State, or Local Regulations or Eliminated by Homeowner”). An “X” in this row means that the method will not be considered in your decision.

The next step is to evaluate the remaining methods (those without an “X” under their names). Your evaluation will be based on the factors listed on the left hand side of the matrix. (The factors are explained below.) For each evaluation factor under each method, discuss your concerns with your local official, design professional, and contractor. If your concerns cannot be resolved, place an “X” in the appropriate box. For example, if you decide that you would not be satisfied with the appearance of your home if it were elevated on extended foundation walls, you would place an “X” in the box on the Appearance line under the heading *Elevation on Extended Foundation Walls*. After you have worked through the entire matrix, add the number of “Xs” under each method and show the sum on the *Total “Xs”* line. The method with the lowest total is probably the one that best meets your requirements.

Table 4-3. Retrofitting Methods for Homes That are NOT Substantially Improved or Damaged

Retrofitting Methods for Homes NOT Substantially Improved or Substantially Damaged								
Evaluation Factors	Elevation			Relocation	Dry Flood-proofing	Wet Flood-proofing	Levees or Flood-walls	Demolition
	Elevation on Extended Foundation Walls	Elevation on Open Foundation	New Living Area over Abandoned First Floor					
								
Prohibited by Federal, State, or Local Regulations or Eliminated by Homeowner								
Appearance								
Cost								
Accessibility								
Code-Required Upgrades								
Human Intervention								
Other								
Total “Xs”								

Evaluation Factors

Federal, State, and Local Restrictions – Federal, State, and local regulations may restrict the homeowner’s choice of retrofitting measures. Such regulations may include State and local building codes, floodplain management ordinance or laws, zoning ordinances, Federal regulations concerning the alteration of buildings classified as historic structures, deed restrictions, and the covenants of homeowners’ associations. The homeowner and the homeowner’s design professional or contractor should check with community officials to determine whether any such restrictions apply.

Appearance – The final appearance of a home and property after retrofitting will depend largely on the retrofitting method used and the DFE. For example, elevating a home several feet will change its appearance much more than elevating it only 1 or 2 feet, and wet floodproofing will change its appearance very little. However, a change in appearance will not necessarily be a change for the worse. The homeowner should discuss the potential effects of each method with local officials and with the design professional or contractor.

Cost – The cost of retrofitting will depend largely on the retrofitting method used and the DFE. For some methods, the construction type (frame, masonry, etc.) and foundation type (crawl space, slab, etc.) will also affect the cost. In general, costs will increase as the DFE increases, but there may be tradeoffs between alternative methods. For example, elevating may be less expensive than relocation when a home is raised only 1 or 2 feet, but may become more expensive at greater heights. Other costs include those for both routine and long-term maintenance.

Accessibility – Accessibility refers to how easy or difficult it is to routinely reach and enter the home after the retrofitting project is completed. The retrofitting methods described in this guide affect accessibility in different ways. For example, elevating a home will usually require the addition of stairs, which may be unacceptable to some homeowners. Levees and floodwalls can make access more difficult unless they are equipped with openings, which require human intervention (see below). Wet floodproofing and dry floodproofing will have little if any effect on accessibility. The effect of relocation on accessibility will depend on the location and configuration of the new site.

Code-Required Upgrades – State and local regulations may require that a retrofitted home be upgraded to meet current code requirements that were not in effect when the home was built. Portions of the electrical, plumbing, and HVAC systems could be affected. For example, the electrical panel might have to be upgraded from fuses to circuit breakers. These changes are required for the safety of the homeowner. Other code-required upgrades include those for increased energy efficiency. Any required upgrade can add to the scope and cost of the retrofitting project. The homeowner and the homeowner’s design professional or contractor should check with community officials to determine whether such regulations apply.

Human Intervention – For retrofitting methods that require human intervention, homeowners must be willing, able, and prepared to take the necessary action, such as operating a closure mechanism in a floodwall or placing flood barriers across the doors of a dry floodproofed

home. Also, the homeowner must always have adequate warning of a coming flood and must be at home or near enough to be able to reach the home and take the necessary action before floodwaters arrive. If these conditions cannot be met, retrofitting methods that require human intervention should be eliminated from consideration.

Other – Homeowners may need to consider other factors, such as the availability of Federal, State, and local financial assistance; the likelihood of future flooding vs. the temporary inconvenience and cost of retrofitting; the amount of time required to complete the retrofitting project; and the need to move out of the home during construction (including the availability and cost of alternative housing).

5.0 Elevating Your Home



5.1 Introduction

One of the most common retrofitting methods is elevating a home. When a home is properly elevated, the living area should be above most flood levels. Several elevation techniques are available. In general, they involve (1) lifting the home and building a new, or extending the existing, foundation below it or, (2) leaving the home in place and either building an elevated “false” floor within the home or adding a new upper story and converting the ground level to a compliant enclosure.

During the elevation process, most frame, masonry veneer, and masonry homes are separated from their foundations, raised on hydraulic jacks, and held by temporary supports while a new or extended foundation is constructed below. The living area is raised and only the foundation remains exposed to flooding. This technique works well for homes originally built on basement, crawlspace, and open foundations. When homes are lifted with this technique, the new or extended foundation can consist of continuous walls or separate piers, posts, columns, or piles. Masonry homes are more difficult to lift, primarily because of their design, construction, and weight, but lifting these homes is possible. In fact, numerous contractors throughout the United States regularly perform this work.

A variation of this technique is used for frame, masonry veneer, and masonry homes on slab-on-grade foundations. In these homes, the slab forms both the floor of the home and either all or a major part of the foundation. Elevating these homes is easier if the home is left attached to the slab and both are lifted together. After the home and slab are lifted, a new foundation is constructed below the slab.

For masonry homes on slab-on-grade foundations, some homeowners find it easier to use an alternative elevation technique, in which the home is left on its original foundation. This technique involves removing the roof and raising the living space, either by extending the walls of the home and raising the floor or by abandoning the lower level and moving the living space to an existing or newly constructed upper floor. The abandoned



NOTE

Always use a licensed, bonded, and insured contractor for elevation projects. Be sure that your contractor has experience with elevation projects and understands the considerations discussed in Section 5.2.

lower enclosed area is then converted to a compliant enclosure that is used only for parking, building access, or storage.

In both of these techniques, portions of the original walls will be below the DFE. This approach is appropriate for masonry construction, which is naturally flood damage-resistant, but not for frame construction, which could be more easily be damaged by floodwaters.

This chapter describes and illustrates the various elevation methods and discusses the most important considerations regarding elevation. While it is important to understand the elevation options, you should never attempt an elevation project without the help of experienced design and construction professionals.

5.2 Considerations

5.2.1 Amount of Elevation

The amount of elevation required is determined by the DFE you have chosen. For example, if your DFE is equal to the BFE, you will need to elevate your home so that the top of the lowest floor is at or above that elevation (see Figure 5-1). As explained earlier, if your home is being substantially improved or has been substantially damaged, your community's floodplain management ordinance or law will require that your lowest floor be elevated to or above the BFE.

If substantial improvement and substantial damage requirements do not apply, you may be able to elevate to any height you wish. But, keep in mind that raising your home to an elevation below the BFE not only provides less protection, it also results in little, if any, decrease in the flood insurance rate. If you decide to raise your home to an elevation below the BFE, the community is required to evaluate the cost of all improvements, including the cost to elevate your home to determine whether your proposed project is a substantial improvement. Regardless of whether your home is being substantially improved or has been substantially damaged, you should consider incorporating at least 1 foot of freeboard into your DFE (as shown in Figure 5-1).

Elevating a home up to 3 or 4 feet above the existing ground level usually will not have a great effect on its appearance and will require only minimal landscaping and regrading. If you plan to elevate more than 4 feet above the existing grade, you should consider elevating your home a full story. Not only will your home be protected against deeper floods, but you can use the space below for parking, building access, or storage (Figure 5-2).



NOTE

FEMA HMA grants will only support elevation to accommodate the DFE. Projects that propose to elevate above the DFE cannot be funded with HMA funds.

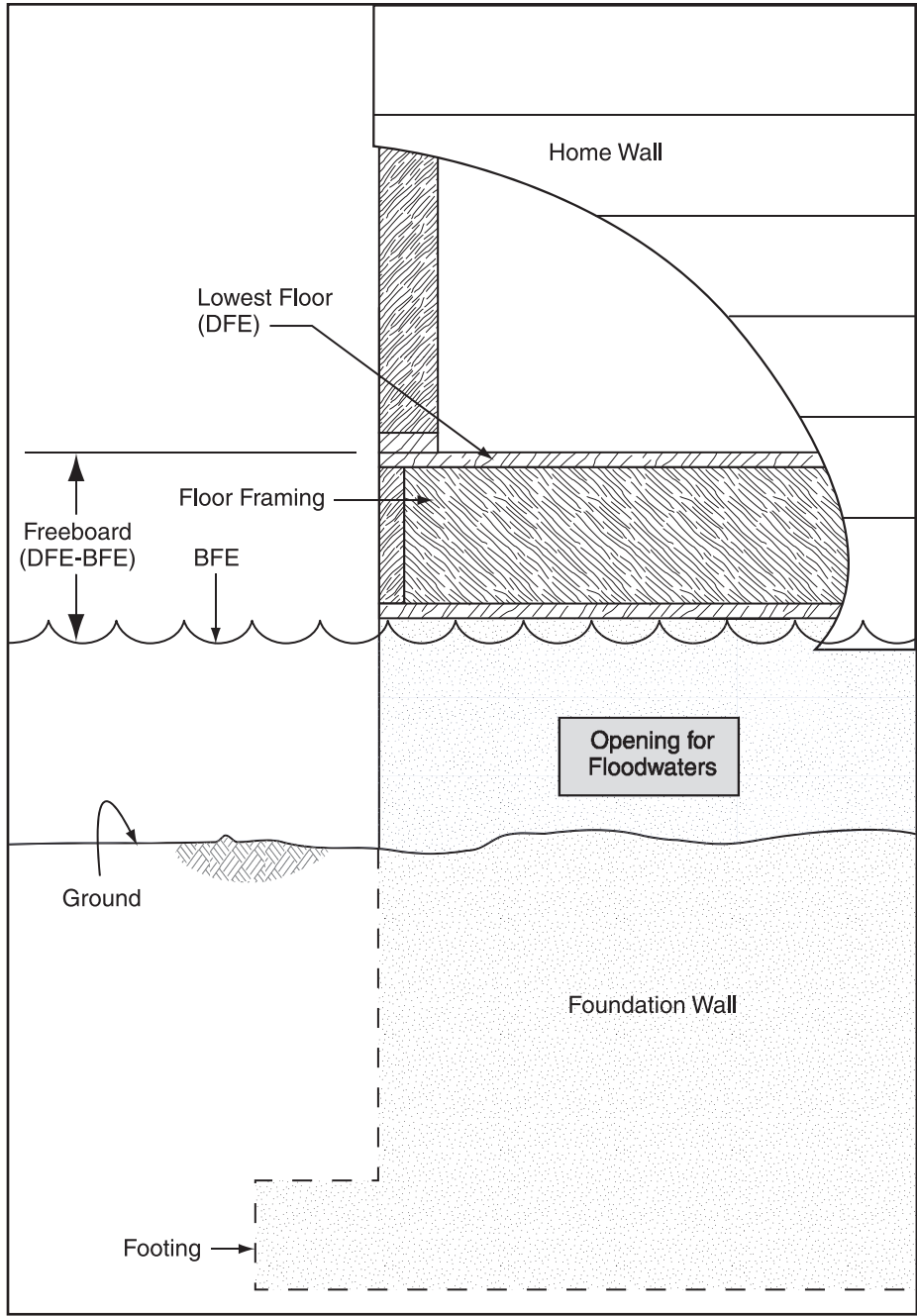

Figure 5-1. As shown in the cutaway view, the lowest floor is above the flood level. When at least 1 foot of freeboard is provided, only the foundation is exposed to flooding.

Figure 5-2. This home in Cedar Falls, Iowa, was elevated one full story. The garage and storage area are at the home's original elevation.



WARNING

If your home is being substantially improved or has been substantially damaged and is in a Coastal High Hazard Area (Zone V, VE, or V1-V30 on the FIRM for your community), your community's floodplain management ordinance or law will require that the bottom of the lowest horizontal structural member (rather than the lowest floor) be elevated to or above the BFE. In many homes, the lowest horizontal structural member is a beam that supports the framing of the lowest floor. With the exception of *Elevating on an Open Foundation* (Section 5.3.3), the elevation techniques presented in this guide are not appropriate for homes in Coastal High Hazard Areas. If you have any doubt about the type of flood hazards that may affect your home, check with your local officials.

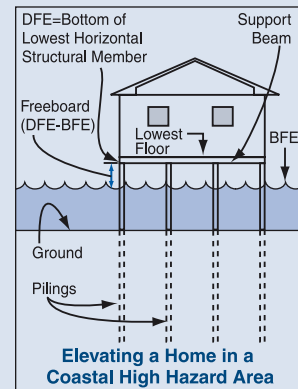

5.2.2 Existing Foundation

In general, the most economical approach to elevating a home is to use as much of the existing foundation as possible. Although some elevation methods do not allow this approach, most do. If you choose one of the latter, a design professional must evaluate the capacity of your existing foundation to support the loads that will be imposed by the elevated home and, as discussed in the next section, the loads expected to result from flooding and other hazards at the site. If changes must be made to the foundation to increase its strength and stability, they can be made as part of your retrofitting project.

The type of foundation on which your home was originally built (basement, crawlspace, slab-on-grade, piers, posts, piles) also can affect the elevation process. This issue is discussed in Section 5.3.3.

5.2.3 Hazards

Because so many elevation techniques are available, elevation is practical for almost any flood situation, but the flooding conditions and other hazards at the home site must be examined so that the most suitable technique can be determined. Regardless of the elevation technique used, the foundation of the elevated home must be able to withstand, at a minimum, the expected loads from hydrostatic pressure, hydrodynamic pressure, and debris impact. It must also be able to resist undermining by any expected erosion and scour.

If you are elevating a home in an area subject to high winds, earthquakes, or other hazards, a design professional should determine whether the elevated home, including its foundation, will be able to withstand all of the horizontal and vertical forces expected to act on it. In making this determination, the design professional must consider a number of factors, including the structure and condition of the home, the soil conditions at the site, the proposed elevation technique, and the hazards at the site. The conclusion may be that additional modifications must be made during the retrofitting project.

5.2.4 Access

Elevating a home usually requires that new means of access be provided. For example, if your entry doors were originally at ground level, new staircases, elevators, or ramps will have to be built. When an attached garage is elevated, providing access for vehicles may require changes to portions of your lot, such as building a new, elevated driveway that ties into high ground elsewhere. This solution can be practical when the amount of elevation required is no more than 2 or 3 feet. As noted earlier, when the amount of elevation reaches 4 or more feet, you should consider elevating your home a full story so that you can use the lower level for parking and avoid the need for an elevated driveway.

The need to provide new means of access is often the main objection that homeowners have to elevating. But functional and attractive solutions to this problem can usually be developed, as shown in Figures 2-2 and 5-3.



WARNING

Fill used for structural support and elevation is prohibited in Coastal High Hazard Areas. Check with your local officials about State and local requirements considering the use of fill. NFIP Technical Bulletin 5, *Free-of-Obstruction Requirements*, offers further guidance about using fill in V zones.

Figure 5-3. With attention to detail and planning, homeowners have created attractive retrofitted homes.



5.2.5 Home Size, Design, and Shape

In general, the larger the home and the more complex its design and shape, the more difficult it will be to lift on jacks. Multistory homes are more difficult to stabilize during the lifting process and, as the dimensions and weight of a home increase, so do the required numbers of jacks and other pieces of lifting equipment. Exterior wall coverings such as stucco and brick veneer complicate the lifting process because they must either be removed or braced so that they will stay in place when the home is lifted. Homes with simple square or rectangular shapes are easier to lift than those with attached garages, porches, wings, or additions, which often must be detached and lifted separately, especially if they are built on separate foundations.

Before a home is lifted, a design professional should inspect it to verify its structural soundness. All the structural members and their connections must be able to withstand the stresses imposed by the lifting process. Lifting an unsound home can lead to potentially expensive damage.

5.2.6 Service Equipment

Before your home is elevated, all utility lines (water, sewer, gas, electric, telephone, etc.) must be disconnected. At the end of the project, the lines will be reconnected and any landscaping that may be necessary will be completed. If you elevate your home on an open foundation, utility lines that enter the home from below may be exposed to damage from flooding and below-freezing temperatures. Protecting utility lines in these situations usually involves anchoring them securely to vertical foundation members and, if necessary, insulating them. All service equipment outside the home, such as air conditioning



DEFINITION

Service equipment includes utility systems, heating and cooling systems, and large appliances in a retrofitted home.

and heat pump compressors, and gas and electric meters, must be elevated to or above the DFE. In homes with basements, any service equipment originally installed in the basement will have to be raised above the DFE, which may require relocation to an upper floor or a small addition to house the equipment. Chapter 8 discusses the protection of service equipment.

5.3 The Elevation Techniques

The elevation techniques and their applications to different types of homes are discussed in the following sections.



5.3.1 Elevating on Extended Foundation Walls

Frame, masonry veneer, and masonry homes can all be elevated on extended foundation walls. As discussed in the following sections, the technique used for homes on basement, crawlspace, and open foundations differs from that used for homes on slab-on-grade foundations.

Homes on Basement Foundations and Crawlspace Foundations

The elevation process is the same for frame, masonry veneer, and masonry homes on basement and crawlspace foundations. Figures 5-4a through 5-4d illustrate the process.

First, holes are made at intervals in the foundation wall so that a series of steel I-beams can be installed at critical points under the floor framing (Figure 5-4a). If the foundation walls are made of concrete blocks, the lifting contractor can remove individual blocks to create the required holes. If the walls are made of poured concrete, the holes will be cut out. The I-beams are placed so that they run perpendicular to the floor joists. A second set of beams is then placed below and perpendicular to the first set (Figure 5-4a). The two sets of beams extend the width and length of the home and form a cradle that supports the home as it is being raised.

In Figure 5-4a, the foundation walls are shown as extending far enough above the ground surface to provide easy access to the area below the floor framing. In some homes, however, the foundation walls will not be this high. To lift such a home, the contractor must first dig trenches at intervals around the foundation. The I-beams are then lowered into the trenches and inserted below the floor framing. The contractor may also have to dig holes for the lifting jacks, as shown in the figure. The number of jacks needed will depend on the size, shape, and type of home being lifted.

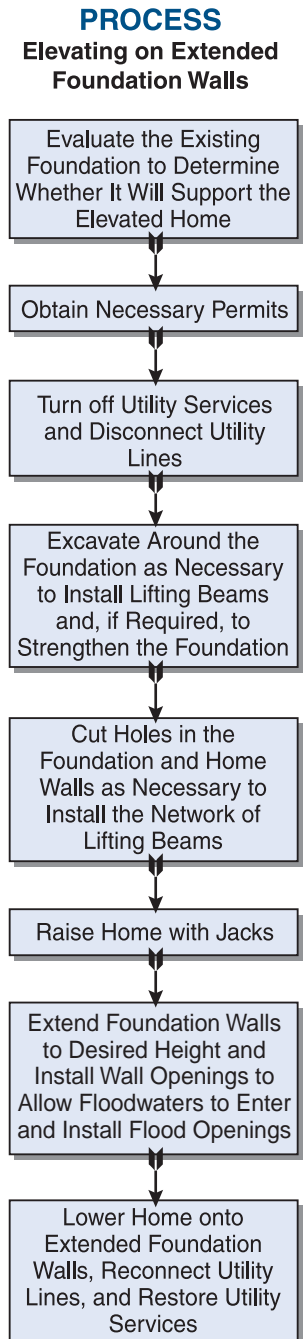

Once the beams and jacks are in place, the elevation process begins. The jacks will extend only so high; so at intervals during the process, the home and jacks are supported temporarily on cribbing while the jacks are raised (Figure 5-4b). After the home is elevated high enough, it is again supported on cribbing while the foundation walls are extended to the desired height with concrete blocks or poured concrete (Figure 5-4c). The home is then lowered onto the extended foundation walls, the I-beams are removed, and the holes where the beams passed through are filled. An important part of the project is installing flood openings in the foundation walls (your building permit will specify the size and location of these openings), no higher than 1 foot above the ground, so that floodwaters can enter and equalize the internal and external hydrostatic pressures. As shown in Figure 5-4c, the contractor may be able to create these openings by only partially filling the I-beam holes.



NOTE

For more information about openings requirements, refer to FEMA Technical Bulletin 1, *Openings in Foundation Walls and Walls of Enclosures*, and FEMA 259, *Engineering Principles and Practices for Retrofitting Flood-Prone Residential Structures*.

Figures 5-4a through 5-4d. Elevating a basement or crawlspace foundation home on extended foundation walls.

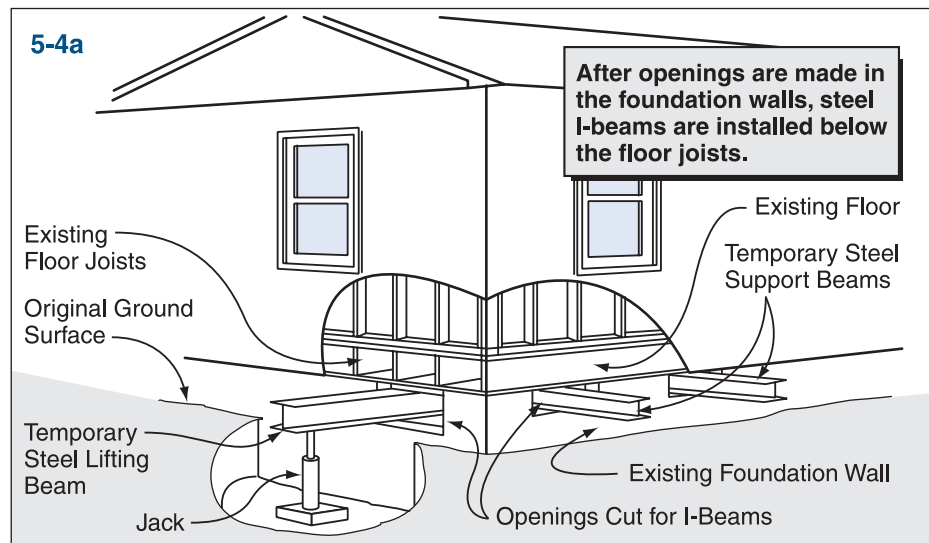

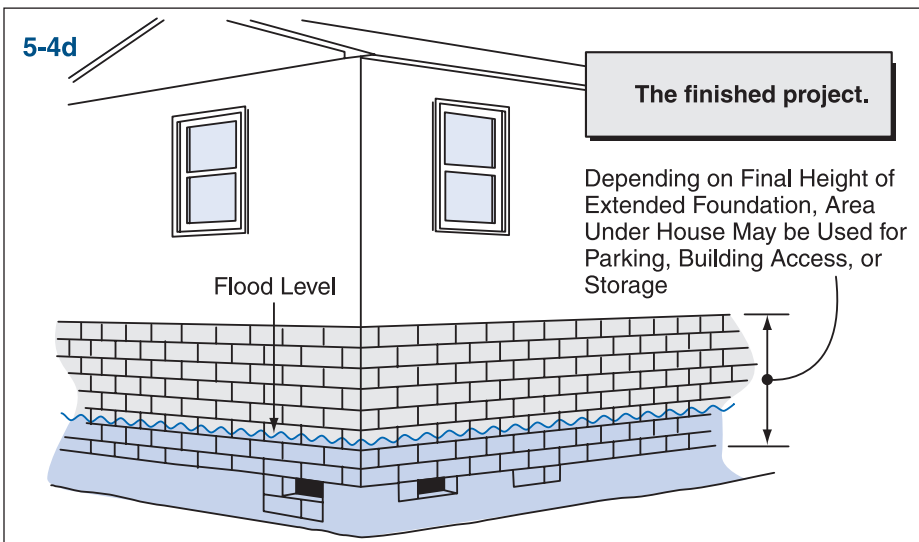
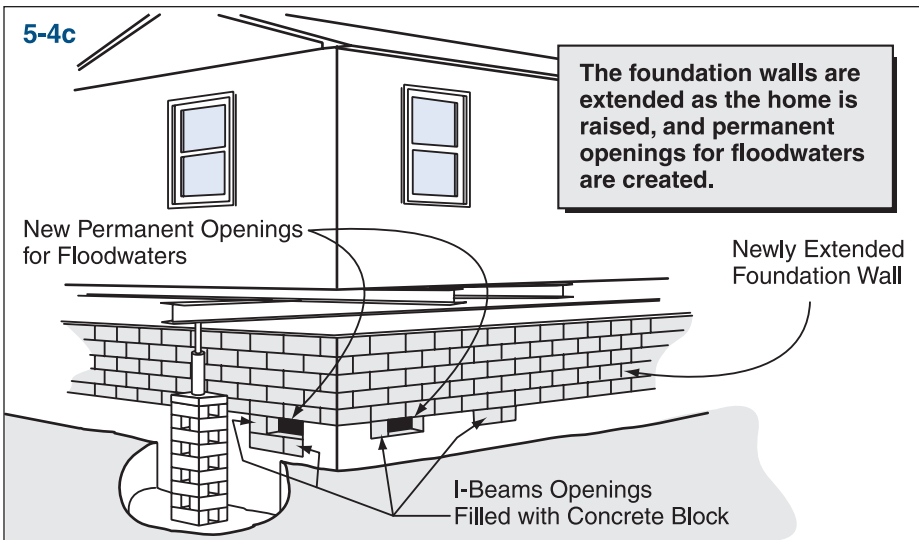
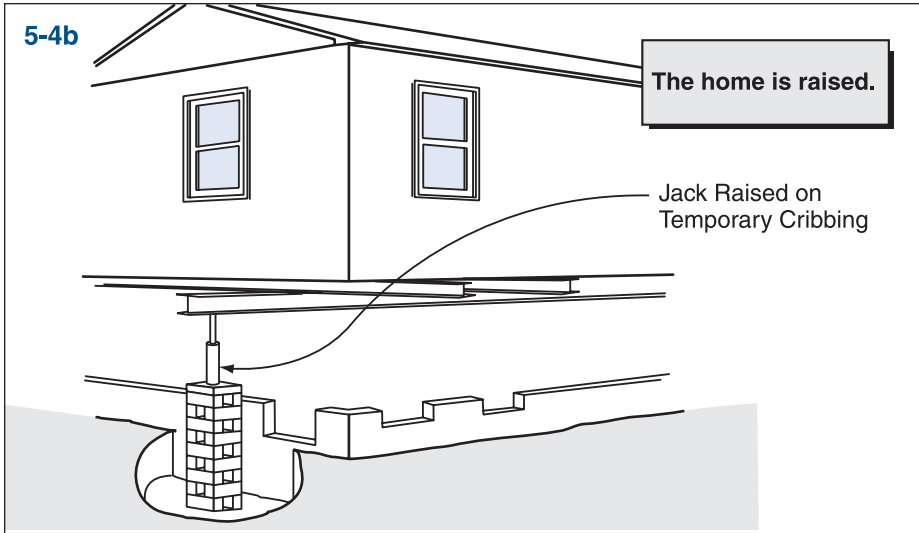

Homes on Slab-on-Grade Foundations

Frame, masonry veneer, and masonry homes on slab-on-grade foundations are also lifted with hydraulic jacks and a network of steel I-beams. However, slab-on-grade homes present special difficulties and require a different lifting technique. An alternative is to leave the existing slab and extend the walls (see Section 5.3.2), or convert the ground level and build a new upper floor (see Figures 5-9a through 5-9c).

The floor of a home on a slab-on-grade foundation is formed by the slab rather than the wood joist and beam framing found in homes on crawlspace and basement foundations. The slab is usually 4 to 6 inches thick and is often reinforced with wire mesh. As shown in the cross-section view in Figure 5-5, the slab can be supported by foundation walls and footings or by a thickened edge created when the slab is poured.

Figure 5-5. Cross-section view of slab-on-grade foundation variations.

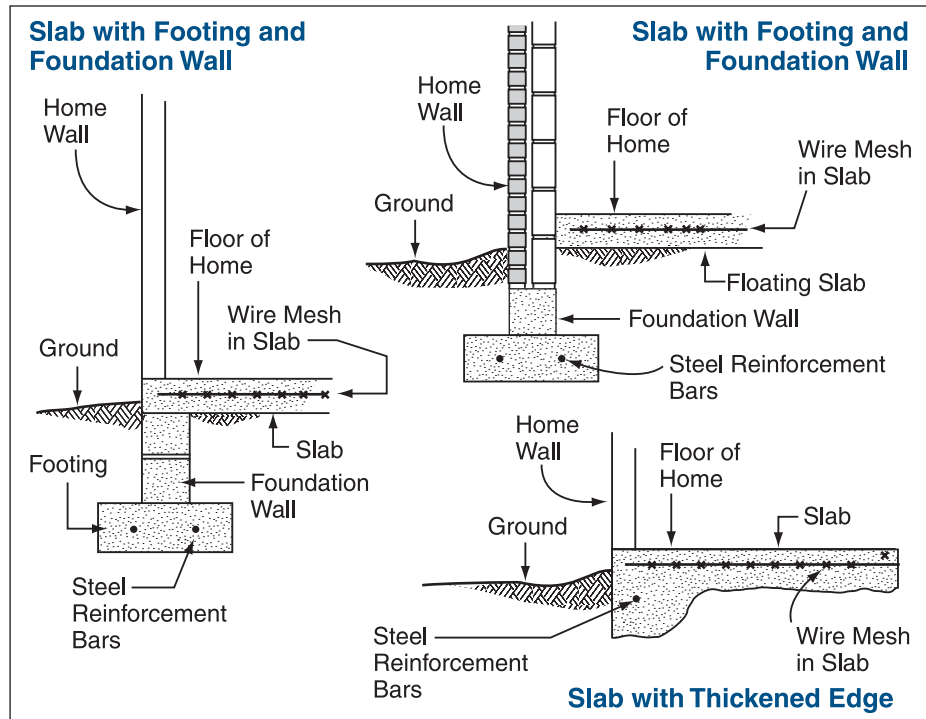

Because the slab forms the floor of the home, and occasionally the foundation as well, elevating the home is easier if the home and slab are lifted together. But this technique is more difficult than that used for homes on basement and crawlspace foundations and should be performed only by a highly skilled contractor with extensive experience in lifting slab-on-grade homes. The wire mesh in the slab is intended to prevent shrinkage and cracking during the original construction of the slab; it is not intended to provide structural strength. As a result, the contractor must take extreme care during the lifting process to avoid breaking the slab and compromising the structural integrity of the home.

The elevation process (Figures 5-6a through 5-6d) is similar to that used for homes on basement and crawlspace foundations, except that the I-beams must be placed below the slab, which is at

ground level. Therefore, the contractor must dig trenches at intervals around the foundation, and tunnel under the slab. The I-beams are lowered into the trenches and moved into place beneath the slab through the tunnels (Figure 5-6a).

The contractor must also dig holes for the lifting jacks because they have to be placed below the beams. Once the beams and jacks are in place, the lifting process begins. As shown in Figures 5-6b and 5-6c, the home is lifted and a new foundation is constructed below it.



NOTE

For more information about openings requirements, refer to FEMA Technical Bulletin 1, *Openings in Foundation Walls and Walls of Enclosures*, and FEMA 259, *Engineering Principles and Practices for Retrofitting Flood-Prone Residential Structures*.

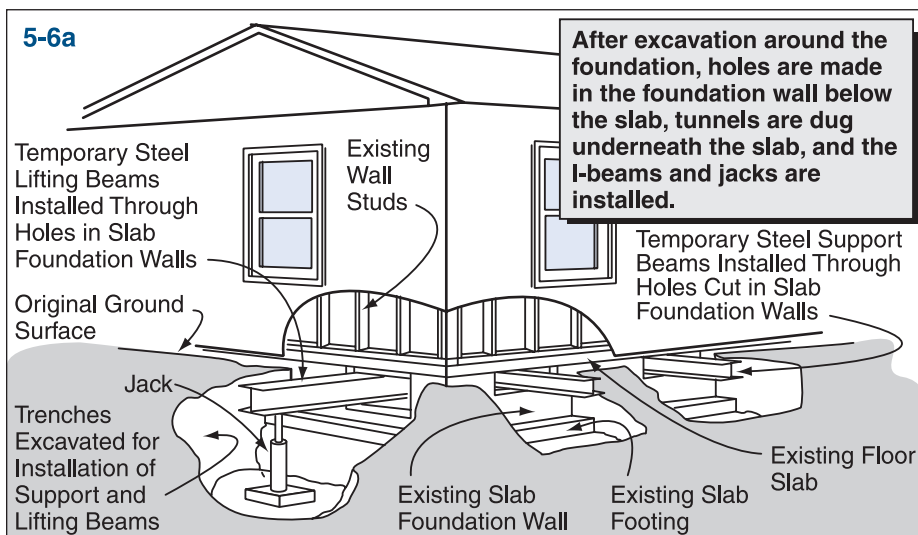

Figures 5-6a through 5-6d. Elevating a slab-on-grade home with the slab attached.

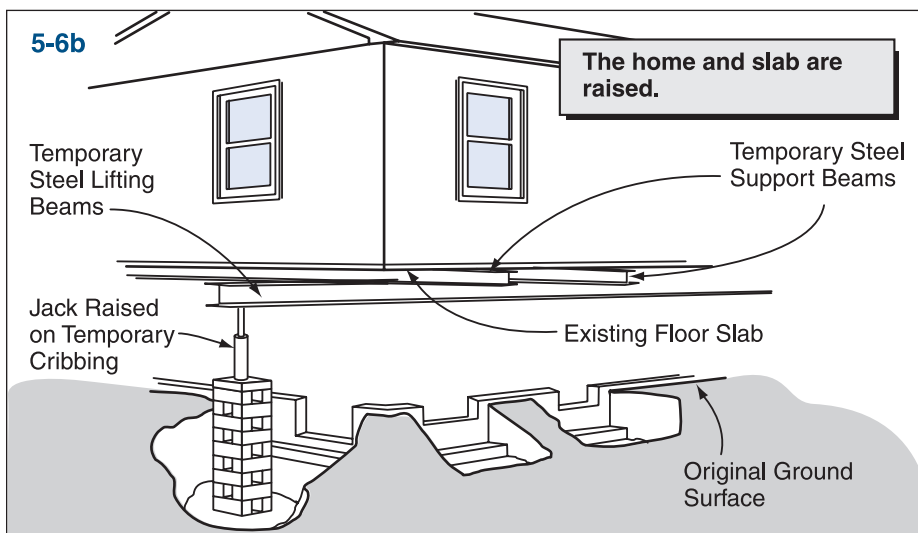

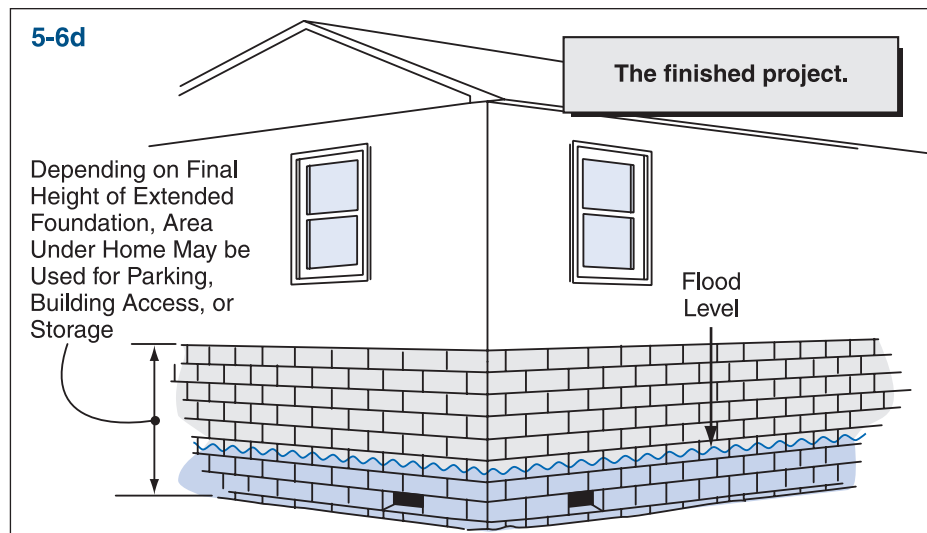
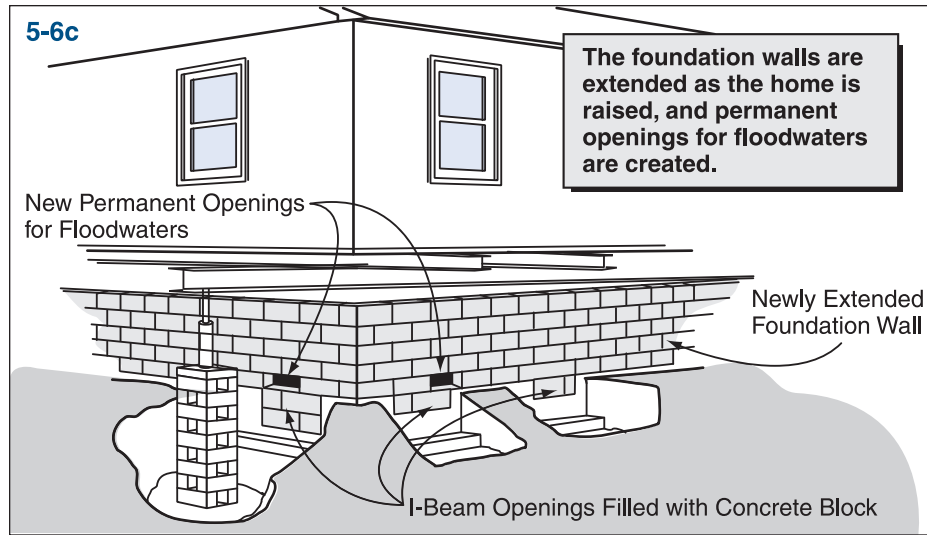

If the slab was originally supported by foundation walls and footings (see upper and left-hand illustrations in Figure 5-5), the contractor may be able to leave them in place and extend the existing walls upward. This approach will be possible only when a design professional determines that the original foundation walls and footings are strong enough to support the elevated home and slab under the expected flood, wind, earthquake, and other loads. If the slab was originally supported by its own thickened edge (shown in the lower illustration in Figure 5-5), a completely new foundation must be constructed.

In both situations, the contractor must construct not only foundation walls under the perimeter of the slab, but also additional vertical foundation members, such as piers, at several locations under the slab. These additional foundation members are necessary because slabs are designed to rest directly on the ground, not to support the weight of the home.

A less frequently used technique for elevating slab-on-grade homes is to separate the home from the slab, lift the home, and leave the slab on the ground. Because the slab is not lifted, the

I-beams are inserted through openings cut into the walls of the home above the slab rather than below it. To enable the beams to lift the home, the contractor attaches horizontal wood bracing to the interior and exterior walls at the tops of the openings (Figure 5-7).

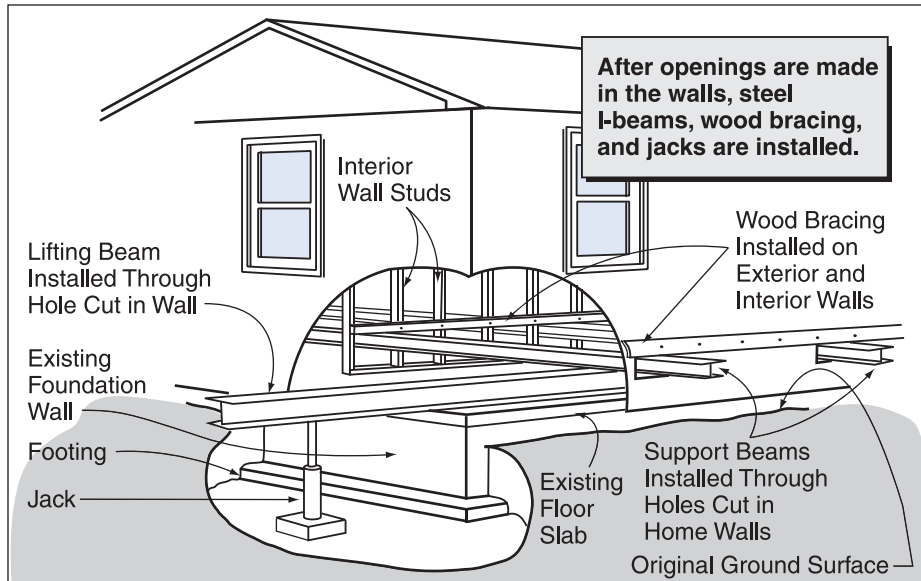

Figure 5-7. Elevating a slab-on-grade home without the slab.

When the beams are jacked up, they push against the bracing, which distributes the lifting force equally across the walls. The bracing also supports the walls, which lack the structural stability that would otherwise be provided when the walls and floor are left attached. Without bracing, the walls could twist, bend, or collapse when the home is lifted. If a design professional determines that the original slab is strong enough to support the elevated home under the expected flood, wind, earthquake, and other loads, the slab may be left in place and the new foundation walls built on top. Otherwise, the slab must be cut back and a completely new foundation constructed, as shown in Figure 5-8.

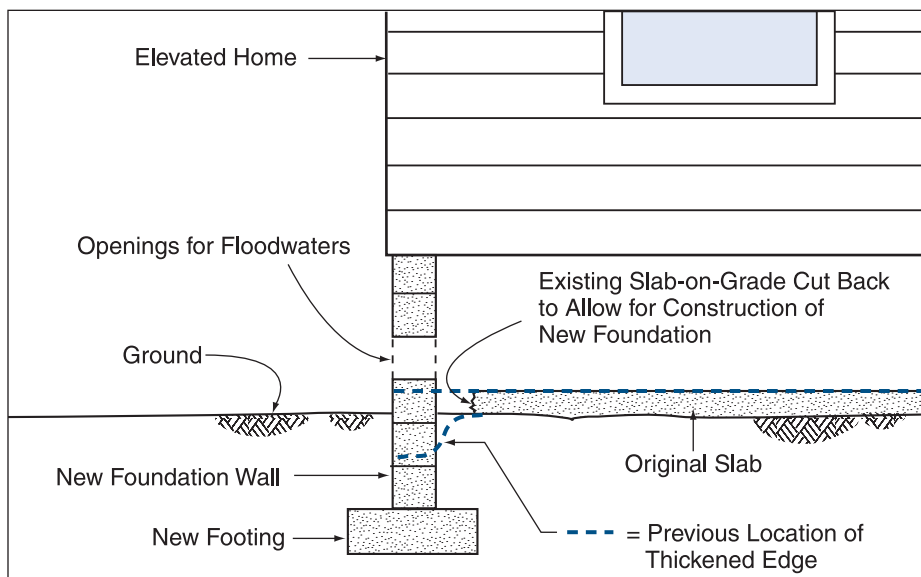

Figure 5-8. Building a new foundation for a slab-on-grade home.

When the slab is not lifted with the home, a new elevated floor must be constructed. The new floor can be a wood-framed floor like that typically found in a home on a basement or crawlspace foundation, or it can be a new elevated concrete slab. Building a new slab floor involves placing fill dirt on top of the old slab and pouring a new slab on top of the fill. Although the old slab is left in place, it is usually broken up so that it will not be forced up by the buoyant effect of floodwaters or saturated soil.

The primary advantage of lifting the home without the slab is that the home is lighter and therefore easier to lift. This benefit applies mainly to frame and masonry veneer homes. This method has several disadvantages, however:

- Cutting holes in the interior and exterior walls of the home and attaching wood bracing causes extensive damage that must be repaired before the elevated home is habitable.
- Because of the damage to the habitable parts of the home, alternative housing may be needed for an extended period.
- The contents of the home must be removed before the elevation process can begin.
- Masonry veneer is likely to interfere with the installation of exterior wall bracing and to crack or break off if left in place during elevation.

Because of these disadvantages, lifting a slab-on-grade home without the slab is normally done only when the home has been severely damaged by a flood or other event and would require extensive repairs regardless of the elevation method used.

5.3.2 Alternative Elevation Techniques for Masonry Homes on Slab-on-Grade Foundations



Elevating by Extending the Walls of the Home

An alternative technique for elevating a masonry home on a slab-on-grade foundation is to extend the existing walls of the home upward and then build a new raised floor above the old slab. This technique is illustrated in Figures 5-9a through 5-9c.

First the roof framing and roof are removed so that the tops of the walls will be accessible. The contractor can then extend the walls upward with additional courses of either concrete block (as shown in Figure 5-9b) or brick or with wood or metal framing. The choice of materials is based on several considerations, including cost, the final appearance of the home, the strength of the existing foundation, and the design requirements associated with the identified hazards, including high winds and earthquakes.

The final height of the extended walls will depend on how high the lowest floor must be elevated. For example, if the lowest floor must be elevated 3 feet to reach the DFE, the height of the walls must be increased by the same amount if the original ceiling heights in the home are to be maintained.

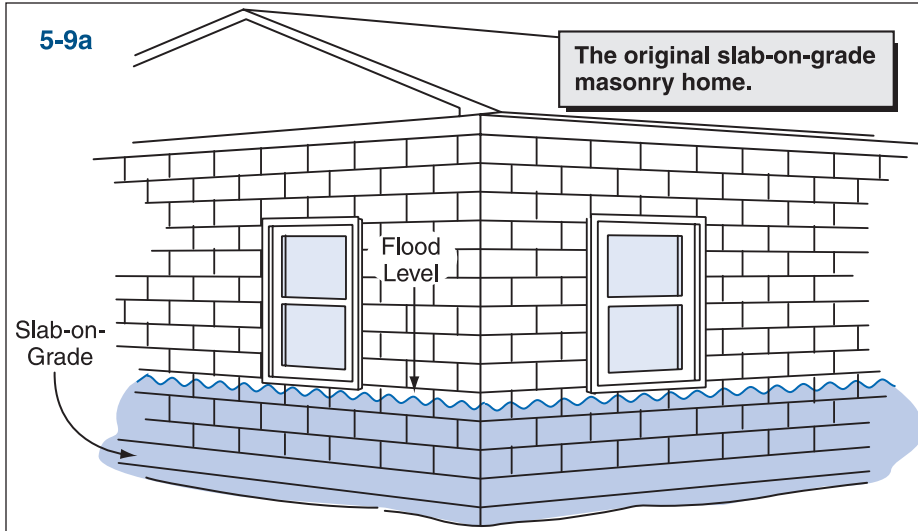

Figures 5-9a through 5-9c. Elevating by extending the walls of a solid masonry home.

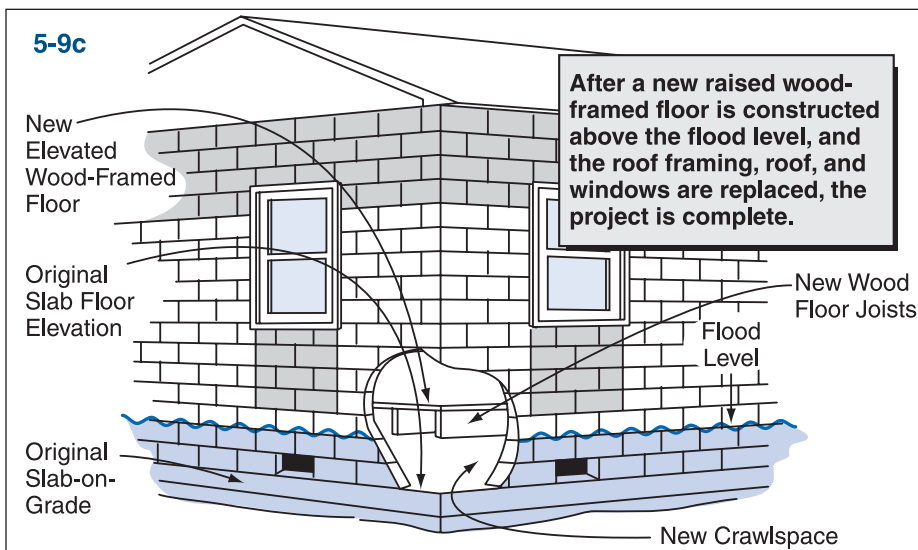
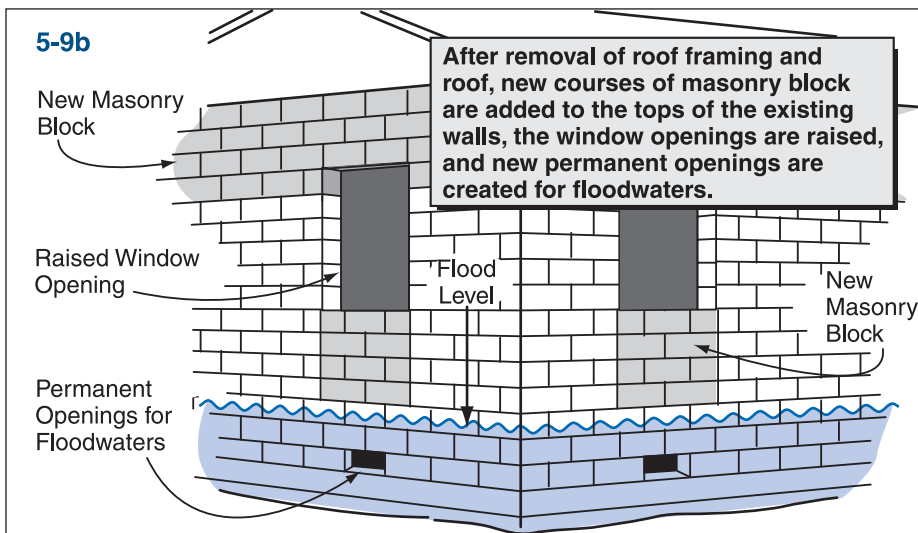

PROCESS

Elevating by Extending the Walls of the Home

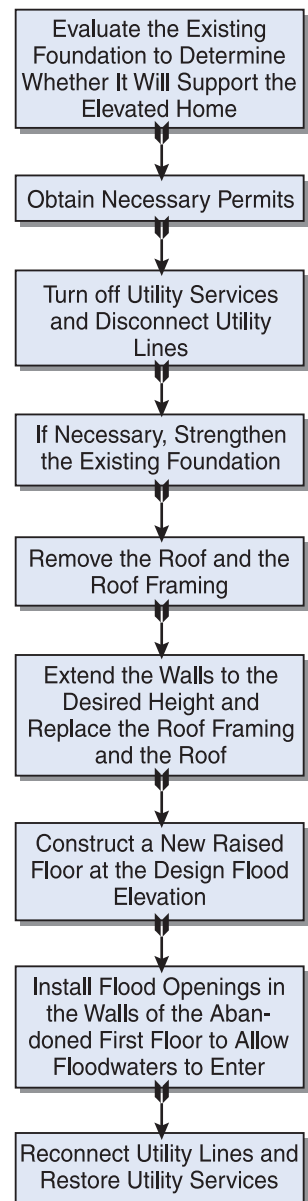

The new raised floor can be either a wood-framed floor system or an elevated concrete slab similar to the original slab (referred to as a stem wall). When a new wood-framed floor system is installed, the area below the floor becomes a crawlspace (as in Figure 5-9c) or other enclosed area that may be used for parking, building access, or storage. Flood openings must be installed in the foundation walls to allow external and internal water pressures to equalize. Additional openings may be needed for ventilation.

For a new elevated slab floor, fill dirt is placed on top of the old slab and compacted as required. Then a new slab is poured on top of the fill. When this method is used, openings in the foundation walls are not required, because the entire area under the new slab is completely filled with dirt and is therefore protected from the pressure of floodwaters.



Elevating by Abandoning the Lower Enclosed Area

Another alternative for a masonry home on a slab-on-grade foundation is to abandon the existing lower enclosed area of the home (the area with the slab floor) and allow it to remain below the DFE. This technique requires that the living area be restricted to upper floors of the home and that the lower enclosed area be used only for parking, building access, or storage. Because this technique leaves the original floor and walls below the DFE exposed to flooding, it is best suited to masonry homes on slab-on-grade foundations. In these homes, both the walls and floor are made of concrete or masonry, which are not easily damaged by contact with floodwaters.

The amount of work required for this technique depends largely on whether the home already has an upper floor that can be used for living space. When an upper floor exists, abandoning the lower enclosed area involves removing easily damaged interior finishing materials below the DFE (including interior wall sheathing and insulation) and elevating or relocating vulnerable appliances (such as furnaces, washing machines, and freezers) and utility system components (such as electrical wiring and service boxes). These modifications are the same as those required for wet floodproofing, as described in Chapter 6.



NOTE

For more information about flood openings, refer to FEMA Technical Bulletin 1, *Openings in Foundation Walls and Walls of Enclosures*, and FEMA 259, *Engineering Principles and Practices for Retrofitting Flood-Prone Residential Structures*.

For one-story homes, abandoning the lower enclosed area requires the construction of a new second story as shown in Figures 5-10a through 5-10c. The required steps are similar to those described in Section 5.3.1. The roof and roof framing are removed, a new second story is built on top of the existing walls, the roof and roof framing are replaced, and openings are added for floodwaters. The construction options are the same: frame or masonry. Again, the choice is based primarily on the considerations of cost, final appearance, the strength of the existing foundation, and the need to address other natural hazards, such as high winds and earthquakes.

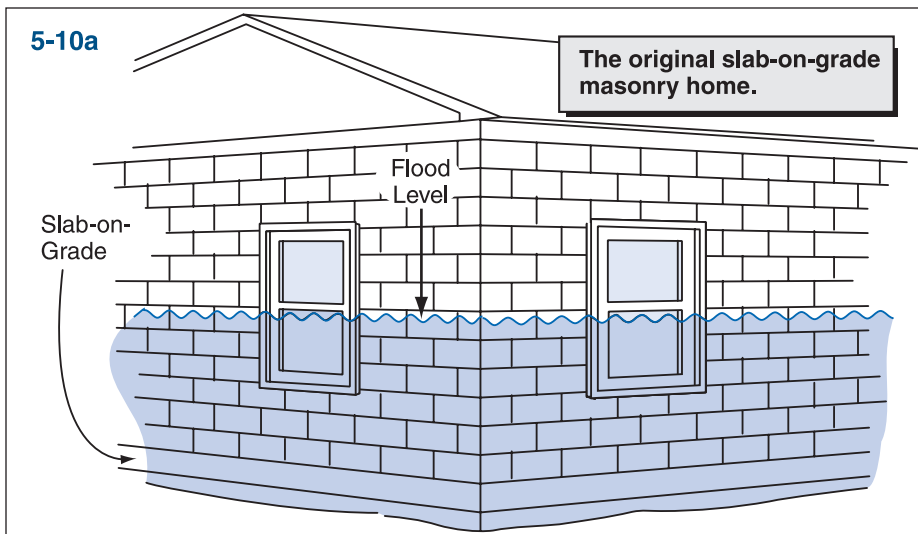

Figures 5-10a through 5-10c. Home elevated by adding a new second story over an abandoned lowest floor.

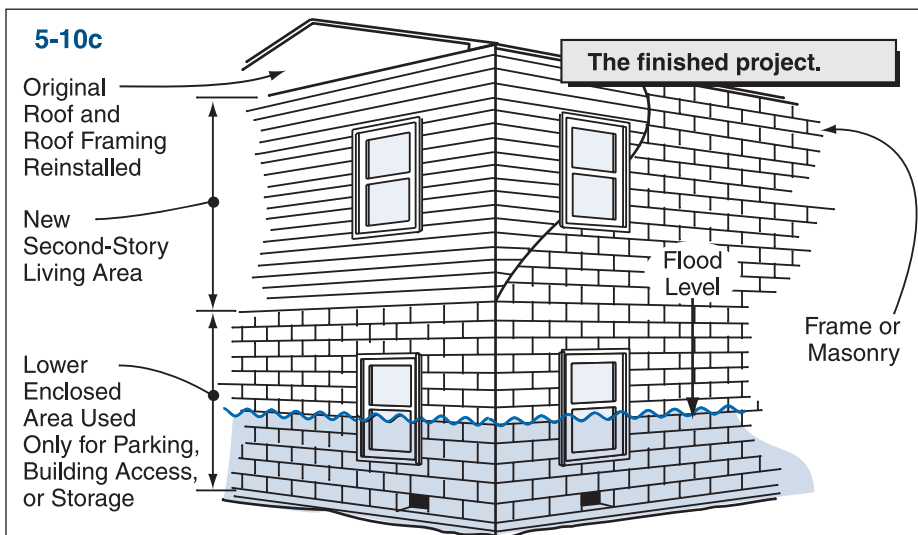
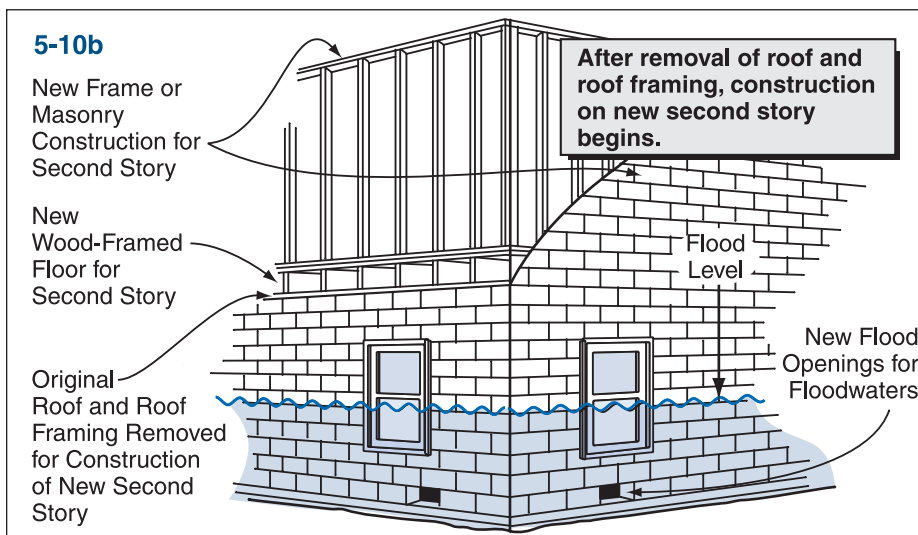

PROCESS
Elevating by Abandoning the Lower Enclosed Area and Building a New Second-Story Living Area

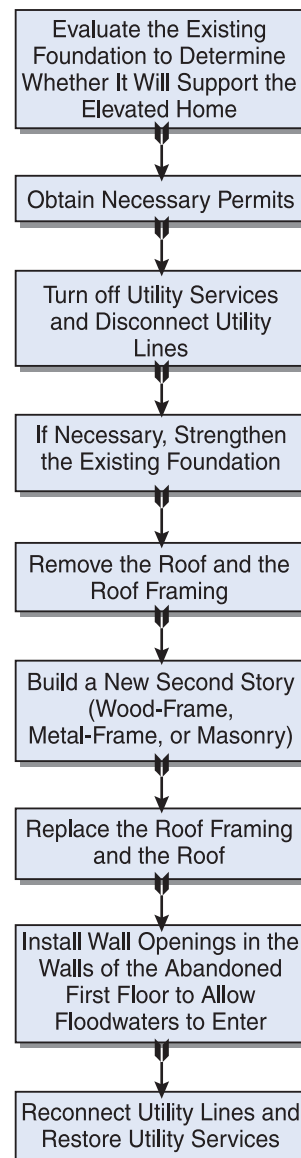



Mitigation Reconstruction

Mitigation reconstruction is the construction of an improved, elevated building on the same site where an existing building and/or foundation has been demolished. Mitigation reconstruction is only permitted if traditional structure elevation cannot be implemented. Activities that result in the construction of new living space at or above the BFE will only be considered when consistent with the mitigation reconstruction requirements.

It may not be feasible to elevate your home. If physical or economic obstacles are too great, you may want to consider demolishing your home and rebuilding a code-compliant home that is elevated above the flood level (see Chapter 7).

Mitigation reconstruction is only an eligible project type under the SRL program (see Chapter 2).



5.3.3 Elevating on an Open Foundation

Frame, masonry veneer, and masonry homes on basement, crawlspace, and slab-on-grade foundations can also be elevated on open foundations consisting of piers, posts, columns, or piles. Homes originally constructed on open foundations can also be elevated this way.

Piers

Figures 5-11a through 5-11d show how a home on a basement or crawlspace foundation can be elevated on masonry piers. The lifting process is the same as that shown in Figure 5-4 for elevating on extended foundation walls. Once the home is lifted high enough, new masonry piers are built on the existing foundation, if it is adequate. If the existing foundation is not adequate to support the elevated home, it will have to be either modified or removed and replaced by separate footings for the individual piers.

An existing basement must be filled in with dirt and graded. An old basement slab can be left in place and covered with fill dirt. But the slab should be broken up so that it would not be forced up by the buoyancy effect of floodwaters. The home in Figure 5-11d has been elevated approximately one full story, and a new concrete slab has been poured at ground level below it. The open area below the home can be used for parking, building access, or storage.

Piers can be constructed of cast-in-place concrete as well as masonry block. However, regardless of the construction materials used, piers are designed primarily for vertical loading imposed by the weight of

PROCESS Elevating on Piers

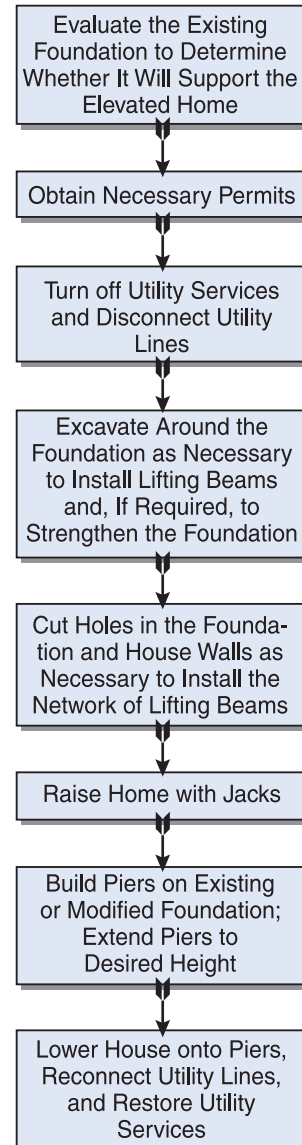

the home, including its contents and any exterior loads such as those imposed by snow. Because the forces associated with flooding, wind, and earthquakes can impose horizontal loads, piers used in retrofitting must be adequately reinforced with steel bars. The connections between the piers and the original foundation and elevated home also must be able to resist the expected horizontal and vertical loads on the home so the home does not shift off the foundation.



NOTE

Open foundations are required for elevations in Coastal High Hazard Areas (Zones V, VE, and V1-V30) and are recommended for elevations in riverine floodplains where flow velocities are greater than 5 fps.

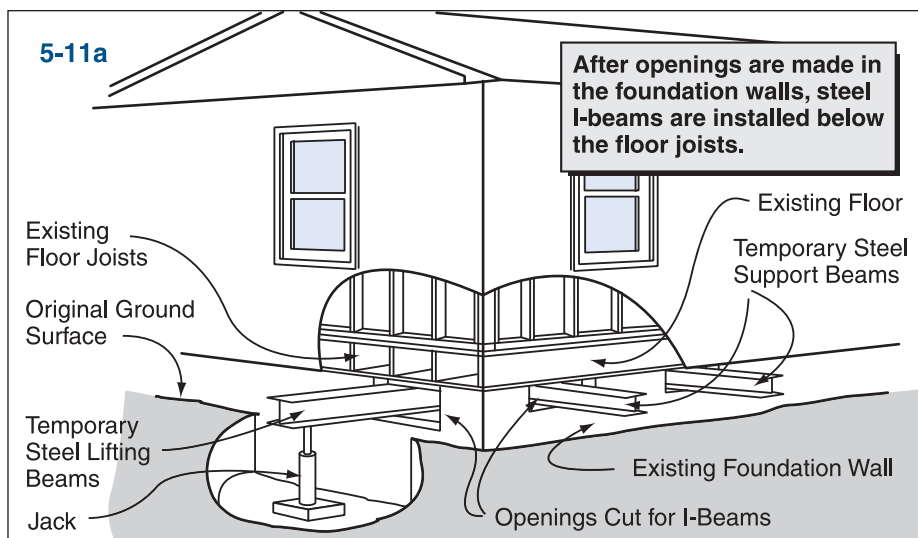

Figures 5-11a through 5-11d. Elevating a basement or crawlspace foundation home on piers.

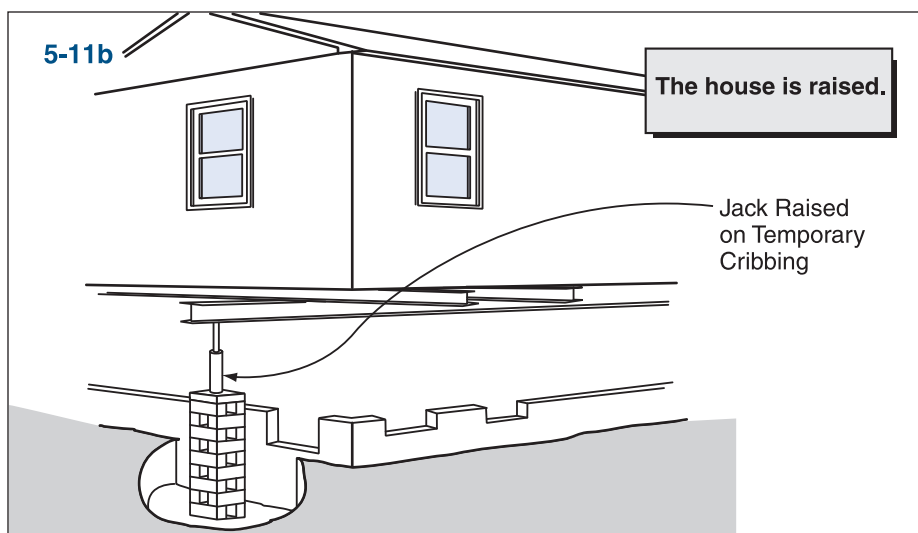

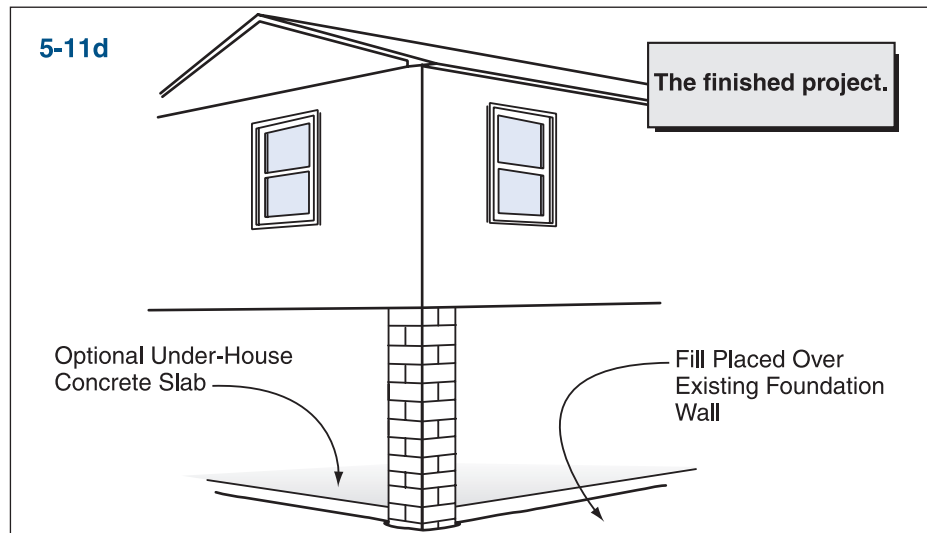
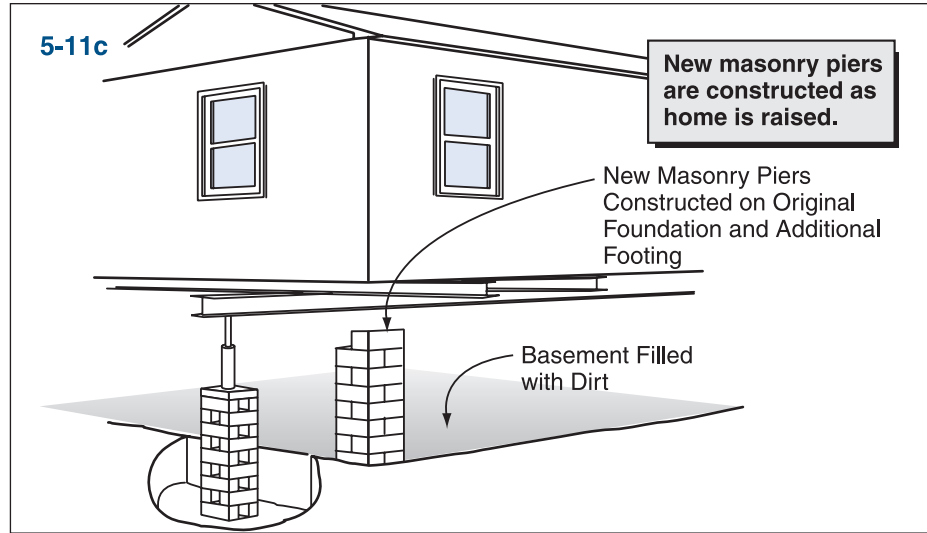

Posts or Columns

Posts are usually placed in drilled or excavated holes. Each post or column is either encased in concrete or anchored to a concrete pad. The home elevation process is the same as that described for piers; however, the existing foundation must be removed so that the posts or columns and their concrete encasements or pads can be installed. Figure 5-12 shows a home elevated on two types of post or column foundations.

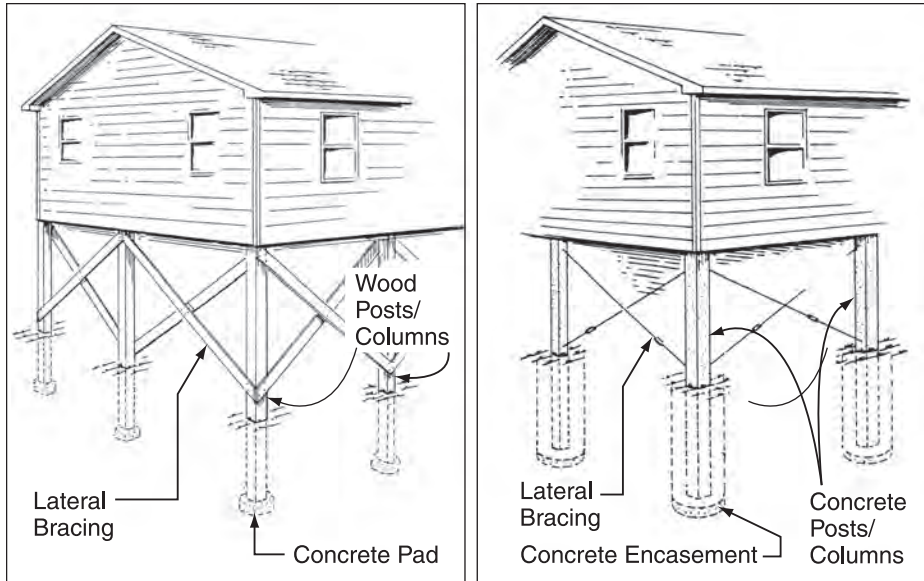

Figure 5-12. Home elevated on post or column foundations.

Piles

Elevating on piles is a more involved process. Piles are usually driven into the ground or jetted in with a high-pressure stream of water. They are not supported by concrete footings or pads. Unlike the construction of wall, pier, or post or column foundations, the pile driving operation, which requires bulky, heavy construction machinery, cannot be carried out under a home that has been lifted on jacks. Instead, the home is usually lifted and moved aside until the piles have been installed. Because the existing foundation is not used, it must be removed. Figure 5-13 shows a home elevated on a pile foundation.

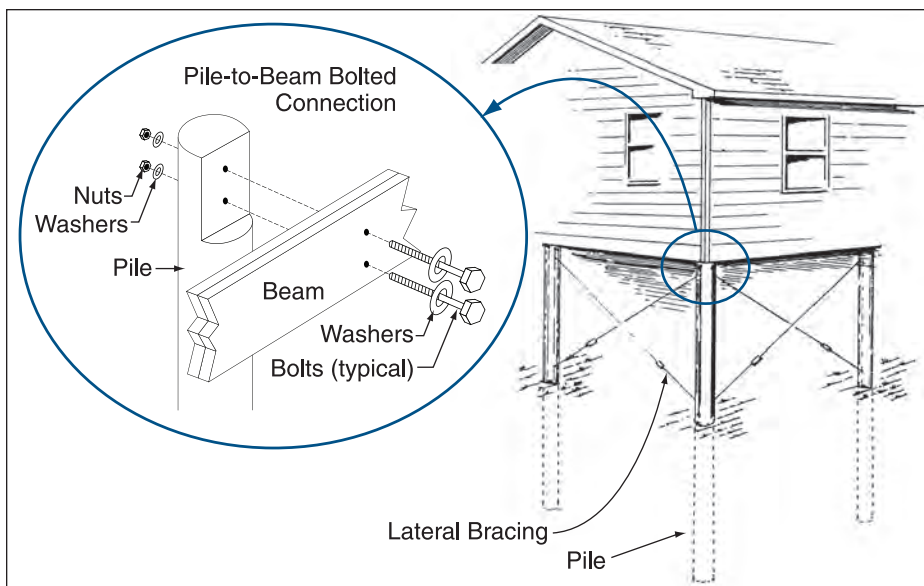
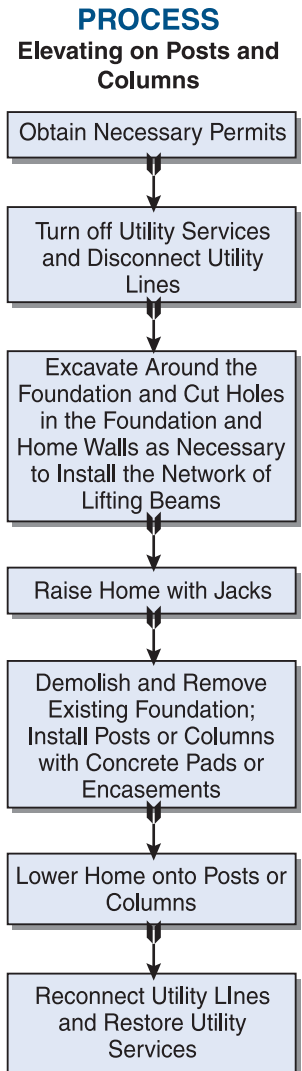

Figure 5-13. Home elevated on piles.



6.0 Wet Floodproofing



6.1 Introduction

This guide describes two types of floodproofing: wet and dry. As its name implies, wet floodproofing allows floodwaters to enter the enclosed areas of a home. In contrast, dry floodproofing (Chapter 7) prevents the entry of floodwaters. The benefit of wet floodproofing is that, if floodwaters are allowed to enter the enclosed areas of the home and to quickly reach the same level as the floodwaters outside, the effects of hydrostatic pressure, including buoyancy, are greatly reduced. As a result, the loads imposed on the home during a flood and, therefore, the likelihood of structural damage may be greatly reduced. Wet floodproofing is generally used to limit damages to enclosures below elevated buildings, walkout-on-grade basements, below-grade basements, crawlspaces, or attached garages. It is not practical for areas that are to be used as living space, and, if the home is substantially improved or substantially damaged, wet floodproofing is not allowed.

Successful wet floodproofing involves the following:

- Ensuring that floodwaters enter and exit the home
- Ensuring that floodwaters inside the home rise and fall at the same rate as floodwaters outside
- Reducing damage to areas of the home that are below the flood level from damage caused by contact with floodwaters
- Protecting service equipment inside and outside the home
- Relocating high-value contents stored below the DFE



WARNING

If your home is being substantially improved or has been substantially damaged, your community's floodplain management ordinance or law will restrict the use of wet floodproofing to attached garages and enclosed areas below the BFE that are used solely for parking, building access, or storage. For more information, refer to FEMA FIA-TB-7, *Wet Floodproofing Requirements*.



WARNING

Wet floodproofing will not reduce flood insurance premiums.

This chapter describes the modifications that must be made to a home as part of a wet floodproofing project, and it discusses the most important considerations regarding wet floodproofing. Protection of service equipment is discussed in Chapter 8.

6.2 Considerations

6.2.1 Design Flood Elevation

All construction and finishing materials in the areas of the home that will be allowed to flood should be resistant to damage caused by direct, and possibly prolonged, contact with floodwaters. Areas used for living space contain floor and wall coverings and other finishing materials, furniture, appliances, and any items that could be easily damaged by floodwaters and expensive to clean, repair, or replace. Therefore, wet floodproofing is practical only for portions of a home that are not used for living space, such as a basement, walkout-on-grade basement, crawlspace, or attached garage. As shown in Figure 6-1, the DFE (including freeboard) should be no higher than your lowest finished floor for wet floodproofing.

If your DFE is above the elevation of your lowest finished floor, you should consider one or more of the other retrofitting methods described in this guide, such as elevation (Chapter 5). If you read Chapter 5, you will note that most of the elevation methods incorporate the principles of wet floodproofing. They raise the living space above the flood level and allow floodwaters to enter the enclosed areas of the home below the living space if those areas have been retrofitting for compliance.

6.2.2 Hazards

Wet floodproofing protects a home from the effects of hydrostatic pressure but not from other flood hazards, such as the hydrodynamic force of flowing water, erosion and scour, saturation of building elements, damage to contents, the impact of ice and other floodborne debris, and damage from floodborne contaminants. If you have seen evidence of these hazards in past floods in your area, or if your community officials confirm that your home may be affected by these hazards, you should consider an alternative retrofitting method, such as relocation (see Chapter 7) or elevation on an open foundation (see Chapter 5). Wet floodproofing a home does not change its vulnerability to damage from high winds or earthquakes.



NOTE

Flood damage-resistant materials are discussed later in this chapter.



NOTE

Always consult a licensed, bonded, and insured contractor for wet floodproofing projects. Be sure that your contractor has experience with wet floodproofing and understands the considerations discussed in Section 6.2.

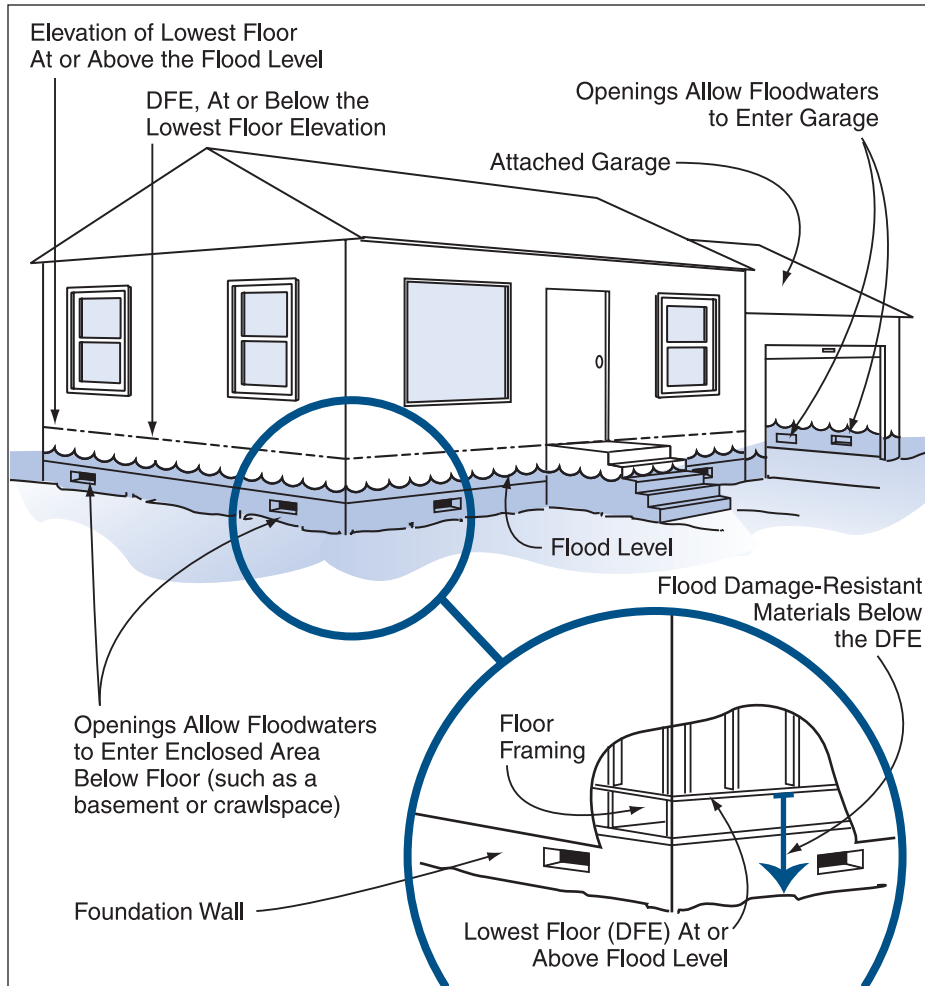

Figure 6-1. A typical use of wet floodproofing.

6.2.3 Post-Flood Cleanup

Remember that floodwaters are rarely clean. They usually carry sediment, debris, and even corrosive or hazardous materials such as solvents, oil, sewage, pesticides, fertilizers, and other chemicals. Allowing areas of a home to flood exposes those areas to whatever is in the floodwaters. Cleaning up a wet floodproofed home after a flood may, therefore, involve not only removing mud, but also washing, disinfecting, and decontaminating walls, floors, and other surfaces. Mold and floodborne contaminants are particularly hazardous and difficult to eradicate. This is another good reason why wet floodproofing is inappropriate for areas used as living space and, in some circumstances, why it may be inappropriate for any part of a home.

Use caution when entering a recently flooded home, watching for structural instability or shifted contents as well as displaced animals that may have been forced from their natural homes by the floodwaters. There are five important steps to take when you first return to a flooded home before beginning repairs. They are:

1. **Air out:** Open all doors and windows, including interior doors.

2. **Move out:** Remove salvageable contents that were not impacted by the water; dispose of all saturated porous materials such as mattresses or upholstery.
3. **Tear out:** Remove all water-damaged interior finishes, including wet carpet and padding, curled vinyl tiles and linoleum, saturated drywall and plaster, saturated wall insulation, flooded electrical receptacles, and swollen wall paneling.
4. **Clean out:** Clean up any remaining debris and muck using squeegees, shovels, brooms, vacuums, and other equipment, and wearing proper personal protective equipment. Remove mold with commercial mold removers and a pressure washer.
5. **Dry out:** Once the cleaning process is complete, the home and any remaining contents need to dry, a process that can take up to 6 weeks. Failure to allow for adequate drying prior to reconstruction can trap moisture in the home, which can cause structural damage and potential health problems over time.



NOTE

If more than 10 square feet are affected by mold, you should contact a mold cleanup professional. For more information about mold prevention and remediation, visit the Center for Disease Control's (CDC's) mold website at <http://www.cdc.gov/mold>.

For more information about restoring flooded buildings or initial precautions to be taken when entering flooded buildings, refer to the Hurricane Katrina Recovery Advisories *Initial Restoration for Flooded Buildings* and *The ABC's of Returning to Flooded Buildings*. The advisories are part of FEMA 549, *Mitigation Assessment Team Report: Hurricane Katrina in the Gulf Coast* and can be downloaded at the FEMA website <http://www.fema.gov/library/viewRecord.do?id=1857>. FEMA 234, *Repairing Your Flooded Home*, also contains useful information about initial repairs, and can be found at <http://www.fema.gov/library/viewRecord.do?id=1418>.

6.3 Modifications Required for Wet Floodproofing

Wet floodproofing requires a variety of modifications to your home, including its walls, construction and finishing materials, and service equipment. It is a good idea to consult with a design professional or licensed contractor before you make any modifications.

6.3.1 Installing Openings

The most important part of a wet floodproofing project is installing wall openings that will allow the entry and exit of floodwaters. The openings must be installed in foundation walls and in



NOTE

For more information about openings requirements for wet floodproofing, refer to FEMA Technical Bulletin 1, *Openings in Foundation Walls and Walls of Enclosures*, and FEMA 259, *Engineering Principles and Practices for Retrofitting Flood-Prone Residential Structures*.

garage walls as appropriate, below the expected flood level (Figure 6-2). The goal is not simply to allow the entry and exit of floodwaters, but also to ensure that the water level inside the home rises and falls at roughly the same rate as the water level outside so that hydrostatic pressures inside and outside are continuously equalized. As shown in Figure 6-2, large differences in the interior and exterior water levels allow unequalized hydrostatic pressures and, therefore, defeat the purpose of wet floodproofing. Figure 6-3 illustrates typical enclosures with flood openings.

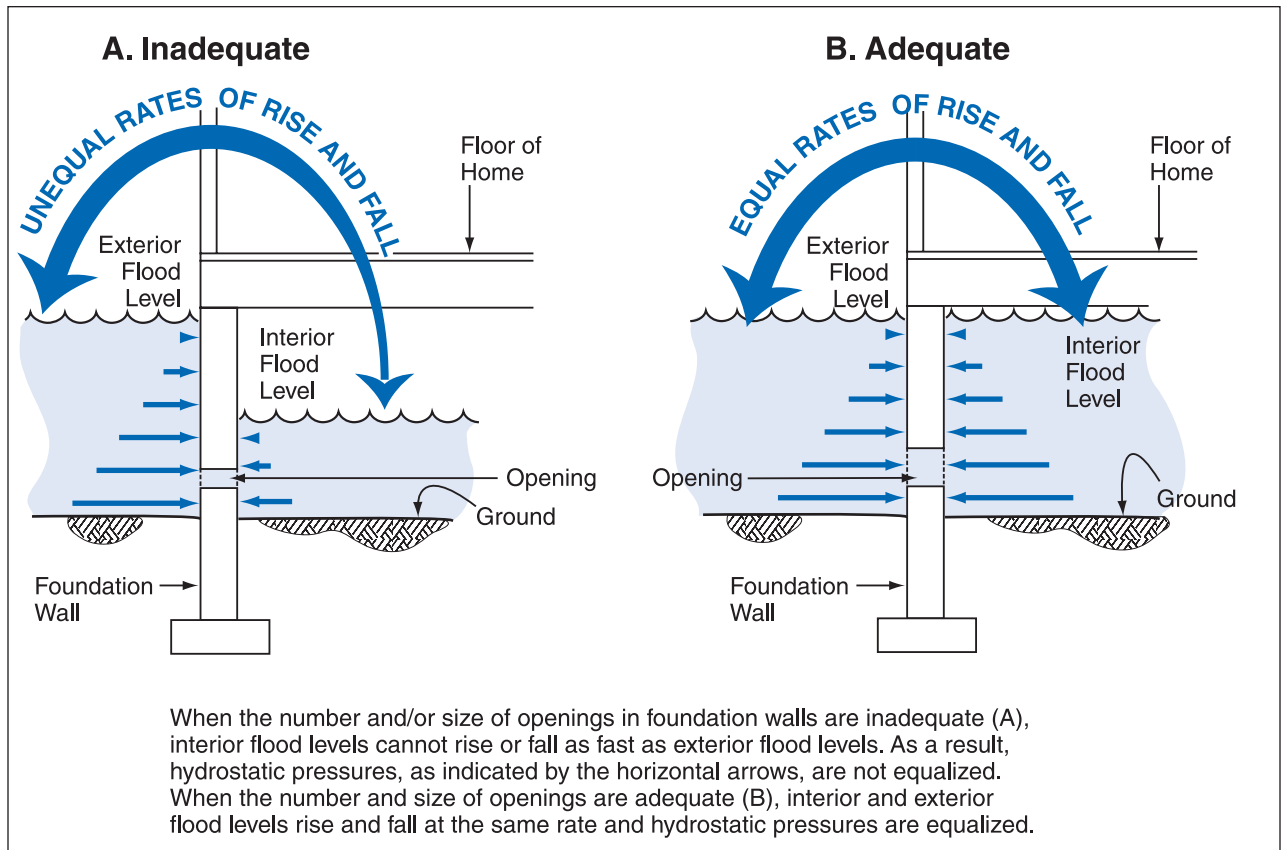

Figure 6-2. Wall openings must allow floodwaters not only to enter the home, but also to rise and fall at the same rate as floodwaters outside the home.



NOTE

If you cover wall openings with louvers or screens, keep in mind that, the more restrictive they are, the more likely they are to become clogged with debris during floods and prevent the flow of floodwaters. Make sure that any screens or louvers you use will allow the passage of water that contains suspended sediment and other small debris. After floodwaters have receded, screens and louvers must be cleaned of any other debris that may have accumulated.

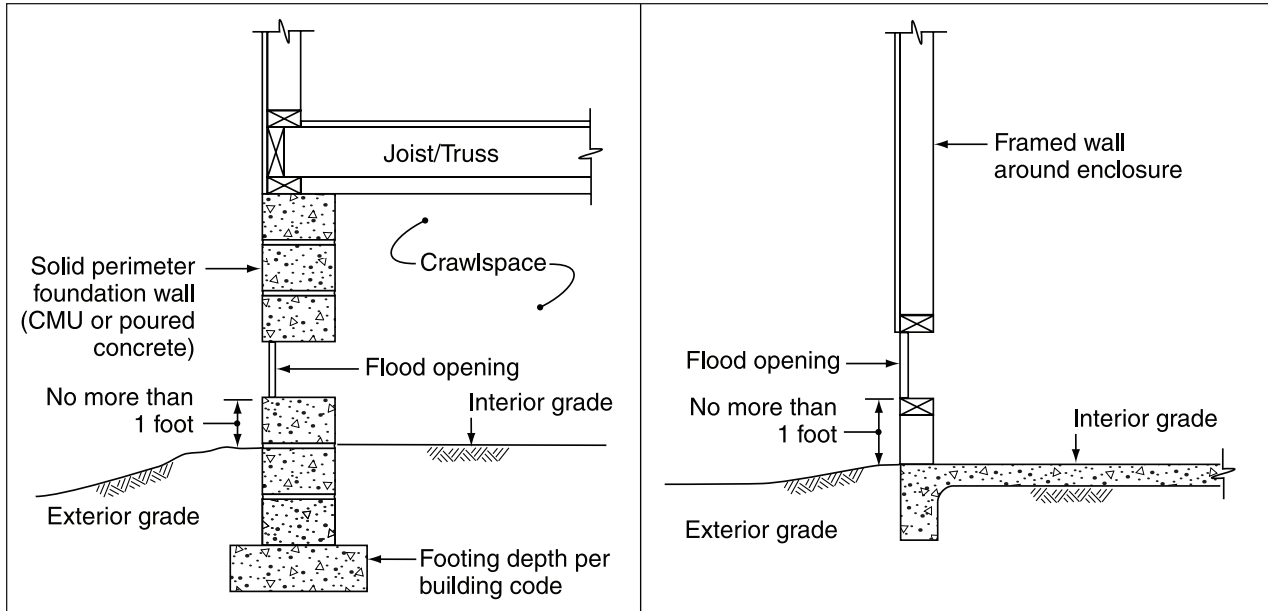

Figure 6-3. Typical enclosures with flood openings.

For equal water levels to be maintained, both the size and number of openings must be adequate. Otherwise, when floodwaters are rising and falling, water will not be able to flow into or out of the home fast enough. The number of openings required and their size will depend on the rate of rise and the rate of fall of the floodwaters (see Chapter 2) and on the size of the area that is being allowed to flood. In general, the faster the rates of rise and fall and the larger the flooded area within the home, the greater the number and size of openings required.

If you are wet floodproofing areas below the BFE in a substantially improved or substantially damaged home, your community's floodplain management ordinance or law will require you to install openings in the exterior walls of all enclosed areas below the BFE (see Section 3.2.1). The minimum requirements are:

- You must provide at least two wall openings for each enclosed area – one in each of two different walls. In other words, you cannot put both openings in the same wall.
- If your home has more than one enclosed area, you must install openings in the exterior walls of each enclosed area so that floodwaters can enter directly from the outside.
- The total area (size) of all openings for each enclosed area must be equal to at least 1 square inch for every square foot of floor space in the enclosed area. For example, if the enclosed area is 25 feet by 40 feet (1,000 square feet), the total net area of the openings must be at least 1,000 square inches, or roughly 7 square feet. In this example, you could meet the size requirement by providing two 3½-square-foot openings or several smaller openings whose total area equals 7 square feet.
- The bottom of each opening must be no higher than 1 foot above the higher of the exterior grade or interior directly below the opening.

- Floodwaters must be able to flow in and out of enclosed areas automatically. If you place louvers, screens, or other types of covers over the openings (which many homeowners do to prevent animals from entering the enclosed areas), they must not block the flow of water. Note that the area of any screens or louvers covering the openings must be subtracted from the gross opening area. Because the need for human intervention reduces the reliability of wet floodproofing, you may not install any type of electrically, mechanically, or manually operated cover.
- Flood openings must be entirely below the BFE.

FEMA developed these requirements to provide homeowners with a straightforward means of determining where and how to install wall openings without the aid of an engineer or design professional. The requirements provide a margin of safety for wet floodproofed homes subject to flooding with rates of rise and fall as high as 5 feet per hour. If you wish to install openings that do not meet one or more of the requirements listed above, your design must be certified by a registered engineer or other licensed design professional and approved by your local officials. See FEMA's Technical Bulletin 1, *Openings in Foundation Walls and Walls of Enclosures*, for more information about openings requirements.

6.3.2 Using Flood Damage-Resistant Materials

In the areas below the anticipated flood level, any construction and finishing materials that could be damaged by floodwaters must be either removed or replaced with flood damage-resistant materials as required by your community's floodplain management ordinance or law. Vulnerable materials include drywall, blown-in and fiberglass batt insulation, carpeting, and non-pressure-treated wood and plywood. Flood damage-resistant materials are those that can be inundated by floodwaters with little or no damage. They include such materials as concrete, stone, masonry block, ceramic and clay tile, pressure-treated and naturally decay-resistant lumber, epoxy-based paints, and metal. In addition to resisting damage from floodwaters and the contaminants they carry, these materials are relatively easy to clean after floodwaters have receded.



NOTE

For more information about flood damage-resistant materials, refer to FEMA Technical Bulletin 2, *Flood Damage-Resistant Materials Requirements*. This bulletin includes a detailed list of common floor, wall, and ceiling materials categorized according to their applicability for use in areas subject to inundation by floodwaters.

Table 6-1 lists materials that are acceptable and unacceptable for use in wet floodproofing projects. NFIP Technical Bulletin 2, *Flood Damage-Resistant Materials Requirements*, offers more complete guidance on materials that can and cannot be used to wet floodproof an area below the DFE. You should consult a design professional before selecting materials to wet floodproof any areas in your home.

Table 6-1. Flood Damage-Resistant Materials

Material Type	Acceptable	Unacceptable
Structural Flooring Materials	<ul style="list-style-type: none"> • Concrete • Naturally decay-resistant lumber • Pressure-treated plywood 	<ul style="list-style-type: none"> • Engineered wood or laminate flooring • Oriented-strand board (OSB)
Finish Flooring Materials	<ul style="list-style-type: none"> • Clay tile • Ceramic or porcelain tile • Terrazzo tile • Vinyl tile or sheets 	<ul style="list-style-type: none"> • Engineered wood or laminate flooring • Carpeting • Wood flooring
Structural Wall and Ceiling Materials	<ul style="list-style-type: none"> • Brick face, concrete, or concrete block • Cement board/fiber-cement board • Pressure-treated plywood • Solid, standard structural lumber (2x4) 	<ul style="list-style-type: none"> • Fiberglass insulation • Paper-faced gypsum board • OSB
Finish Wall and Ceiling Materials	<ul style="list-style-type: none"> • Glass blocks • Metal cabinets or doors • Latex paint 	<ul style="list-style-type: none"> • Wood cabinets and doors • Non-latex paint • Particleboard cabinets and doors • Wallpaper

6.3.3 Protecting Service Equipment

When you wet floodproof a home, you should also protect the service equipment below the anticipated flood level, both inside and outside the home in accordance with NFIP requirements. Service equipment includes utility lines, heating ventilation and cooling equipment, ductwork, hot water heaters, and large appliances. Chapter 8 describes a variety of methods you can use to protect interior and exterior service equipment.

7.0 Relocation and Other Methods

7.1 Introduction

This chapter describes four alternatives to elevation (Chapter 5) and wet floodproofing (Chapter 6):



Relocation

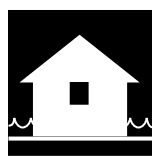

Dry Floodproofing



Levees and Floodwalls



Demolition

These methods can be as effective as either elevation or wet floodproofing, but they are used less often because they are costly and more complex.

Keep in mind that, since each of these options is complex, you should consult design and/or construction professionals to help with your retrofit project.

7.2 Relocation



7.2.1 Introduction

Relocation – moving your home out of the flood hazard area – offers the best protection from flooding. It also can free you from anxiety about future floods and lower your flood insurance premiums. However, relocation usually is the most expensive of the retrofitting methods.

The relocation process involves lifting a home off its foundation, placing it on a heavy-duty flat-bed trailer, hauling it to a new site outside the flood hazard area, and lowering it onto a new conventional foundation. The process sounds straightforward, but a number of considerations require careful planning.

7.2.2 Considerations

Condition of Home

For a home to be picked up and moved successfully, it must be structurally sound. All the structural members and their connections must be able to withstand the stresses imposed when the home is lifted and moved. Before the home is lifted, the home moving contractor must inspect it to verify its structural soundness. A home that is in poor condition, especially one that has been damaged by flooding, may need so much structural repair and bracing that relocation will not be practical (see Section 7.5 for demolition).

Home Size, Design, and Shape

In general, the types of homes that are the easiest to elevate (as discussed in Section 5.2.5) are also the easiest to relocate: single-story, wood-frame homes over a crawlspace or basement foundation, especially those with a simple rectangular shape. These homes are relatively light, and their foundation design allows the home moving contractor to install lifting equipment with relative ease. Multistory homes and solid masonry homes are more difficult to relocate because their greater size and weight requires additional lifting equipment and makes them more difficult to stabilize during the move. Slab-on-grade foundations complicate the relocation process because they make the installation of lifting equipment more difficult.

The relocation process is also more complicated for homes with brick or stone veneer, which can crack and peel off when disturbed. It may be cheaper to remove the veneer before the home is moved and replace it once the home is on the new foundation at the new site. For the same reason, chimneys may need to be removed before the move and rebuilt afterwards. If they are to be moved with the home, they must be braced extensively.

Moving Route Between Old and New Sites

Restrictions along the route to the new site can complicate a relocation project, especially for large homes. Narrow roads, restrictive load capacities on roads and bridges, and low clearances under bridges and power lines can make it necessary to



NOTE

Always use a licensed, bonded, and insured contractor for relocation projects. Be sure that your contractor has experience with relocation projects and understands the considerations discussed in Section 7.2.2.

For information about home relocation companies, contact the International Association of Structural Movers (IASM) at P.O. Box 2637, Lexington, SC 29071, (803) 951-9304, <http://www.iasm.org/>.



NOTE

Relocation is sometimes used as an alternative to demolition (as described in Section 7.5) when a home has been damaged. Instead of demolishing the home, the owner may be able to sell it for salvage to a contractor, who will then move the home to another site, renovate it, and sell it. Relocation can also occur after a community acquires a flood-prone property from the owner. Instead of leaving the home to be demolished, the owner may decide to keep the home and move it to property outside the flood hazard area.

find an alternative route. When no practical alternatives are available, the home moving contractor may have to cut the home into sections (as shown in Figure 7-1), move them separately, and reassemble the home at the new site. Experienced home movers can make the cuts and reassemble the home in such a way that it will not appear to have ever been apart.



Figure 7-1. When a home is too large to be moved in one piece, it may have to be cut into sections that can be moved separately and then reassembled at the new site.

Disruption of Occupants

Among all the retrofitting methods, relocation is the most disruptive for the occupants of the home. Before the home can be lifted, all utility systems must be disconnected and the home becomes uninhabitable. You will not be able to move back in until the home has been installed at the new site and all utility systems reconnected. In the interim, you will need temporary lodgings and a place to store your furniture and other belongings.

7.2.3 The Relocation Process

The relocation process consists of more than lifting and moving the home. You must work with your contractor to select a new site for the home, and the contractor must plan the moving route, obtain the necessary permits, prepare the new site, and restore the old site.

Selecting the New Site

Selecting a new site for your relocated home is similar to selecting a site on which to build a new home. You need to consider the following:

Natural Hazards – Remember that the goal of relocating is to move your home to a site that will be



NOTE

See Section 4.2.3 for information about working with local officials regarding flood hazards and permitting requirements in your community.

safe from flooding and other natural hazards. Before buying new property, check with local officials about the flood, wind, and earthquake hazards at any new site you may be considering (see Section 4.2.3).

Utilities – Determine what is needed to install new utility systems and to have utility lines extended to your new site. You need to consider electrical, gas, water and sewer, telephone, and cable TV services. Your community will probably require that your new utility systems meet current code requirements. Regardless of these requirements, you should to consider upgrading one or more of your utility systems to provide more energy-efficient service.

Accessibility – Your new site must be accessible to the home movers and to the construction crews that will prepare the site and build the new foundation for your home. The more difficult it is for contractors to reach and work at your new site, the more expensive your relocation project is likely to be. If extensive grading and clearing are necessary for adequate access, some of the characteristics that made the site attractive to you may be diminished.

Another important consideration regarding accessibility is the difficulty of moving the home to the new site. In determining the best route between the old and new sites, the moving contractor must anticipate potential problems, such as narrow bridges. For example, the progress of the home may be impeded by narrow bridges and road cuts, bridges with low weight limits, low-hanging utility lines and traffic signals, low underpasses, tight turns, road signs, and fire hydrants.

The moving contractor should be responsible for coordinating any special services that may be required to deal with obstacles, such as raising traffic lights, relocating signs, and constructing temporary bridges. Utility lines can usually be raised temporarily during the move, but utility companies often charge for this service. In some cases, it may be possible to avoid some obstacles by choosing an overland (non-road) travel route.

Permitting

You or your moving contractor will have to obtain permits to move the home on public roads or other rights-of-way. These permits may be required by local governments, highway departments, and utility companies, not only in the jurisdiction from which your home is being moved, but also any jurisdiction through which the home will pass. If the moving route crosses or affects private land, you may need to obtain the approval of the landowner.



NOTE

Regardless of the age of your home, you may be required by local regulations to bring it up to current code when you move it to a new site. This requirement could affect not only the home but also its utility systems. You should check with your local officials about such requirements before you decide to relocate.

Obtaining the necessary permits and approvals may be a lengthy and complex process, and you may find that the requirements vary from jurisdiction to jurisdiction and agency to agency. So it is extremely important that you, your design professional, and your moving contractor investigate the need for permits and approvals before you make a final decision to relocate.

You or your design professional should check with local officials to make sure that, when your home is moved to the new site, it will conform to all zoning requirements and building codes in effect at the time of the relocation. The design professional should also determine the local design standards and permitting requirements that govern the development of your new site. All permits required for construction at the new site, moving your home, and restoring the old site after the home is moved should be obtained before the relocation project begins.

Preparing the New Site

Before the home is moved, the new foundation is designed and is usually partially constructed. The foundation will be completed after the home is brought to the site. Clearing, excavation, and grading are necessary to allow construction to begin and to ensure that the home can be maneuvered on the site. Also, unless already available, utility service must be brought into the site so that there will be no delay in connecting them to the home and making it habitable.

Lifting the Home

In general, the steps required in lifting a home off its foundation are the same as those described in Section 5.3.1 for elevating a home on extended foundation walls. As described in Section 5.3.2, the steps for homes on basement and crawlspace foundations differ from those for homes on slab-on-grade foundations.

Homes on basement and crawlspace foundations are separated from their foundations and lifted on steel I-beams that pass through the foundation walls directly below the floor framing. The lifting is done with hydraulic jacks placed directly under the I-beams. The process for homes on slab-on-grade foundations is similar. However, because these homes are lifted with the concrete floor slab attached, the I-beams are inserted below the slab.



NOTE

Refer to Section 5.3 for a description of how homes on various types of foundations are lifted off their foundations.

Moving the Home

After the home is lifted, the moving contractor performs whatever grading and excavation are necessary to create a temporary roadway that will allow the home to be moved to the street. The area beneath the home must be leveled and compacted so that trailer wheel sets can be placed under the home (Figure 7-2). The wheel sets and lifting beams form the trailer on which the home will be moved.

Figure 7-2. Trailer wheel sets are placed beneath the lifting beams.



After the wheels are attached, a tractor or bulldozer tows the home to the street. As the home is being moved, workers continually block the wheels to prevent sudden movement. At the street, the home is stabilized, the trailer is attached to a truck, and the move to the new site begins (Figure 7-3).

Figure 7-3. The move to the new site begins.



At the new site, the moving contractor positions the home over the partially completed foundation and supports the home on cribbing so the trailer wheels can be removed. As in the home elevation process described in Chapter 5, the home is lifted on hydraulic jacks to the desired height and the foundation is completed below it (Figure 7-4). The home is then lowered onto the foundation, all utilities are connected, and any necessary backfilling and landscaping is completed.



Figure 7-4. After the home is raised into place, the foundation is completed.

Restoring the Old Site

After the home is moved, the old site must be restored according to the requirements of local regulations. Restoring the site usually involves demolishing and removing the old foundation and any pavement, such as a driveway or patio; back-filling an old basement; removing all abandoned utility systems; grading to restore areas disturbed by demolition; and stabilizing the site with new vegetation. Permits are normally required for demolition, grading, and vegetative stabilization.



NOTE

Many homeowners have sold or deeded vacated flood-prone properties to local municipalities for use as parkland or open space.

If your old site included a septic tank or fuel storage tank, you may have to meet the requirements of environmental regulations aimed at preventing contamination of the groundwater. Depending on the age and condition of the tank, you may be required to drain and remove it. If it is an underground tank, you may have to drain and anchor it to prevent flotation. You may also be required to test the soil around an underground fuel tank to determine whether leakage has occurred. As the homeowner, you will usually be responsible for cleaning contaminated soil if there has been any leakage from the tank. In this situation, you will need the services of a qualified geotechnical or environmental engineer.

Local utility companies or regulatory officials can inform you about requirements concerning capping, abandoning, or removing various utility system components.

7.3 Dry Floodproofing



7.3.1 Introduction

Dry floodproofing involves completely sealing the exterior of a building to prevent the entry of floodwaters. Unlike wet floodproofing (Chapter 6), which allows water to enter the building through wall openings, dry floodproofing seals all openings below the flood level and relies on the walls of the building to keep water out.

Because the walls are exposed to floodwaters and the pressures they exert, dry floodproofing is practical only for homes with walls constructed of flood damage-resistant materials and only where flood depths are low (no more than 2 to 3 feet). Successful dry floodproofing involves the following:

- Sealing the exterior walls of the home
- Covering openings below the flood level
- Protecting the interior of the home from seepage
- Protecting service equipment outside the home

The following sections discuss the most important considerations regarding dry floodproofing and describe the modifications that must be made to a home as part of a dry floodproofing project. Protection of service equipment is discussed in Chapter 8.

7.3.2 Considerations

Flood Depth

The primary consideration in dry floodproofing, and the one that imposes the greatest limitations on the application of this method, is the effect of hydrostatic pressure. Because dry floodproofing prevents water from entering the home, the external hydrostatic pressure exerted by floodwaters is not countered by an equal force from water inside the home (see Chapter 2). This external pressure results in two significant



WARNING

Dry floodproofing cannot be used to bring a substantially improved or substantially damaged home into compliance with the requirements of your community's floodplain management ordinance or law. In addition, dry floodproofing measures can fail during larger flood events.



NOTE

For additional information about dry floodproofing techniques, refer to FEMA Technical Bulletin 3-93, *Non-Residential Floodproofing—Requirements and Certification* and FEMA 259, *Principles and Practices for Retrofitting Flood-Prone Residential Structures*.

problems: heavy unequalized loads on the walls of the home and buoyancy, or uplift force, which acts on the entire home.

When water rises against a wall, it pushes laterally against the wall. As the depth of water increases, so does this force, as indicated by the arrows in Figure 7-5. Tests performed by the U.S. Army Corps of Engineers (USACE)¹ have shown that, in general, the maximum allowable flood depth for masonry and masonry veneer walls is approximately 3 feet. In these tests, walls exposed to greater depths of water either collapsed or suffered serious structural damage.

Although definitive testing has not been carried out for conventional frame walls without masonry veneer, it is generally accepted that they are difficult to seal, weaker than masonry and masonry walls, and thus likely to fail at lower water depths.

Hydrostatic pressure is exerted not only by floodwater, but also by soils saturated by floodwaters. As a result, basement walls can be subjected to pressures much greater than that from 3 feet of water alone (Figure 7-6). These pressures can easily cause basement walls to buckle inward or collapse (Figure 2-8). For this reason, dry floodproofing in basements is strongly discouraged. In fact, your community's floodplain management ordinance or law does not allow basements in substantially improved or substantially damaged homes to be dry floodproofed.

As shown in Figure 7-6, water and saturated soils also push up from below the home. This buoyancy force causes additional problems and creates a potential for damage that underscores the need to restrict dry floodproofing to areas where flood depths are low and to prohibit dry



WARNING

The flood depth limits discussed here are provided as general guidelines only. Before you attempt to dry floodproof your home, a design professional, such as a structural engineer, must inspect it to determine whether it is structurally sound.

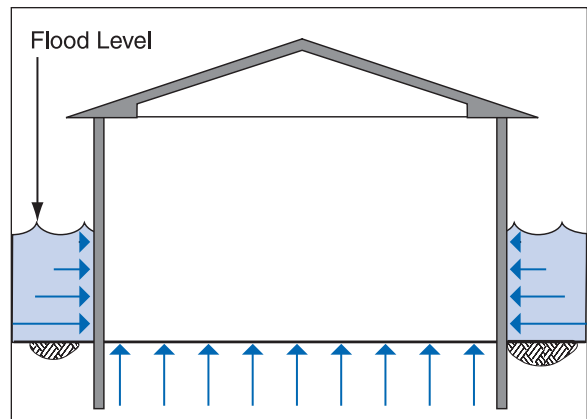

Figure 7-5. The hydrostatic pressure exerted by floodwater (including buoyancy) increases with depth.



NOTE

Always consult a licensed, bonded, and insured contractor for dry floodproofing projects. Be sure that your contractor has experience with dry floodproofing and understands the considerations discussed in Section 7.3.2.

¹ The test results are documented in the following reports published by the USACE National Flood Proofing Committee: *Flood Proofing Tests – Tests of Materials and Systems for Flood Proofing Structures*, August 1988; *Systems and Materials to Prevent Floodwaters from Entering Buildings*, May 1985; *Structural Integrity of Brick-Veneer Buildings*, 1978; *Tests of Brick-Veneer Walls and Closures for Resistance to Floodwaters*, May 1978.

floodproofed basements. The buoyancy force resulting from flood depths of over 3 feet can separate a dry floodproofed home from its foundation and buckle concrete slab floors in dry floodproofed slab-on-grade homes. It may be difficult to imagine, but it is possible for a home with a dry floodproofed basement to be pushed out of the ground during large floods.

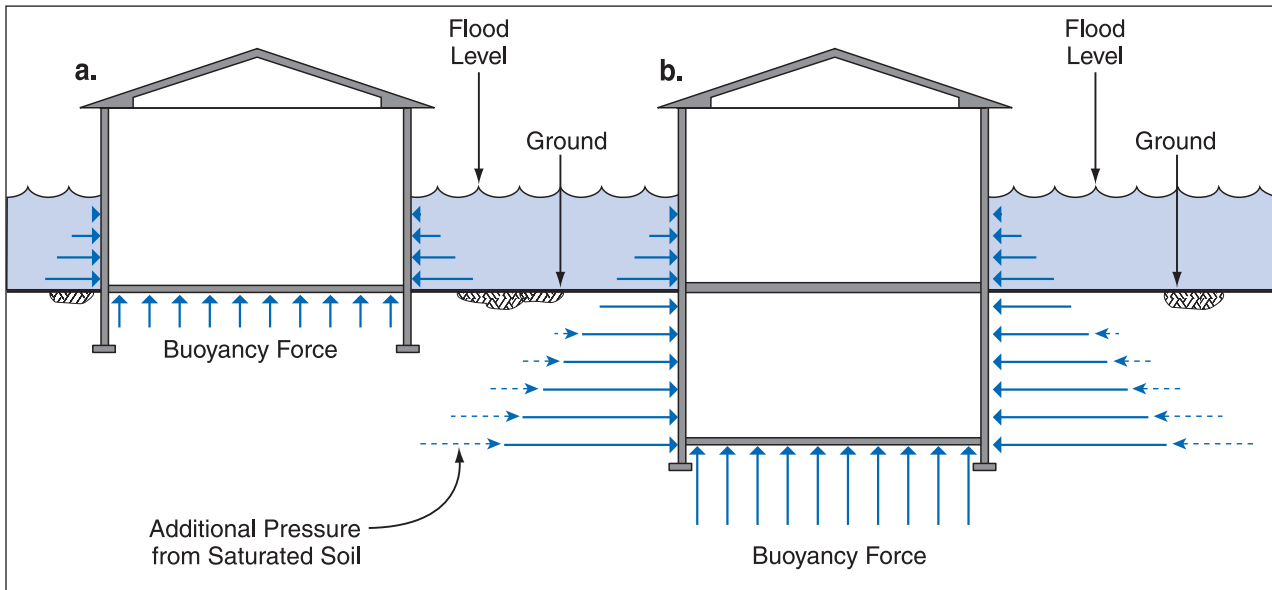

Figure 7-6. The lateral and buoyancy force resulting from the same depth of flooding is much less on a home without a basement (a) than on a home with a basement (b). The pressure on basement walls is caused by water and saturated soils.

The degree of danger posed by buoyancy depends on the flood depth, the type of soil at the home site, how saturated the soil is, the duration of the flood, whether the home has a drainage collection and disposal system, and how well that system works. Only an experienced engineer can evaluate these factors.

Flow Velocity, Erosion and Scour, Debris Impact, and Wave Action

Dry floodproofing does not protect a home from the hydrodynamic force of flowing water, erosion and scour, the impact of ice and other floodborne debris, or wave action. If your home is located in an area subject to any of these hazards, you should consider an alternative retrofitting method, such as elevation on an open foundation (Chapter 5), relocation (Section 7.2), or demolition (Section 7.5). Dry floodproofing a home does not change its vulnerability to damage from high winds or earthquakes.

Flood Duration

Flood duration is an important consideration because the potential for seepage through and deterioration of the materials used to seal the home increase with the length of time that the home is exposed to flooding. Also, the longer the duration, the greater the likelihood that the

soil beneath and adjacent to the home will become fully saturated and add to the loads on the walls and floor (Figure 7-6). If your home is in an area where floodwaters remain high for days, weeks, or even months at a time, you should consider an alternative retrofitting method, such as elevation or relocation.

Human Intervention

Dry floodproofing systems almost always include components that have to be installed or activated each time flooding threatens. One example is a flood shield placed across a doorway. For this reason, dry floodproofing is not an appropriate retrofitting method in areas where there is little or no flood warning or where, for any other reason, the homeowner will not be able or willing to install shields or other components before floodwaters arrive.

Post-Flood Cleanup

Remember that floodwaters are rarely clean. They usually carry sediment, debris, and even corrosive or hazardous materials such as solvents, oil, sewage, pesticides, fertilizers, and other chemicals. The walls of a dry floodproofed home will be exposed to whatever is in the floodwaters. Cleaning up a dry floodproofed home after a flood may, therefore, involve not only removing mud and debris from around the home, but also decontaminating or disinfecting walls and other exterior surfaces.

7.3.3 Modifications Required for Dry Floodproofing

Dry floodproofing involves the use of sealants and shields, installation of a drainage system, and protection of service equipment.

Sealants

Except for some types of high-quality concrete, most wall materials are not impervious to water. Therefore, sealants must be applied to the walls of a dry floodproofed home to prevent leakage. Flexible sealants are compounds (such as asphalt coatings) or materials (such as polyethylene film) that are applied directly to the outside surface of the home walls. Sealants must also be applied to all structural joints, such as the joint between the walls and a slab floor, and to any other openings below the flood level, such as those where utility lines enter the home through the walls or floor.

Sealants that can be applied to outside walls include cement- and asphalt-based coatings and clear coatings such as epoxies and polyurethanes. Cement- and asphalt-based coatings are often the most effective, but they can change the appearance of the wall (Figure 7-7). For example, the aesthetic advantage of a brick wall is lost when these coatings are applied over the brick. Clear coatings do not change the appearance of the wall, but are less effective.

Figure 7-8, a cross-section view of an exterior wall, shows one method of sealing masonry walls with an asphalt-based coating that does not detract from their appearance. In this method, a

new masonry veneer is added to the existing veneer after the coating is applied. In addition to maintaining the look of the wall, the new veneer helps protect the wall against damage from floodborne debris.

Figure 7-7. A 12-inch high asphalt coating was added to this brick wall.



Figure 7-8. New brick veneer added over asphalt coating.

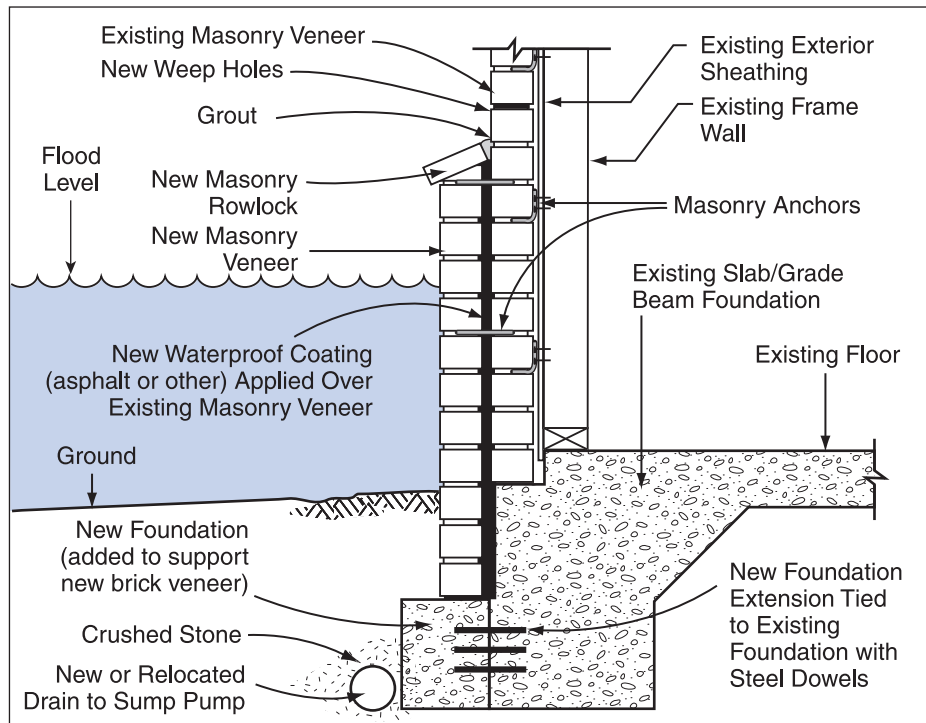

An alternative to using coatings is to temporarily wrap the entire lower part of the home in polyethylene film when flood conditions threaten. This alternative is sometimes referred to as the “wrapped home” technique. The cross-section view in Figure 7-9 shows how this technique works. There must be at least several hours of warning time in order to properly deploy this method.

Polyethylene film is not a strong material – it cannot withstand water pressure on its own and can be punctured fairly easily. As a result, the following requirements must be met when the wrapped home technique is used:

- The installation must be carried out very carefully. Even a small hole in the film will leak under the pressure of floodwaters.
- The film must be applied directly against the walls of the home so that the walls, rather than the film, provide the resistance to water pressures.
- Where the film covers doorways and other openings, it must be backed by framed plywood panels that are braced to resist water pressures.
- A temporary drainage system must be provided to collect and dispose of any water that leaks through holes in the film. (Drainage systems are discussed later in this section.)
- The duration of flooding should be less than 12 hours and the flood depth adjacent to the home should not exceed 1 foot.

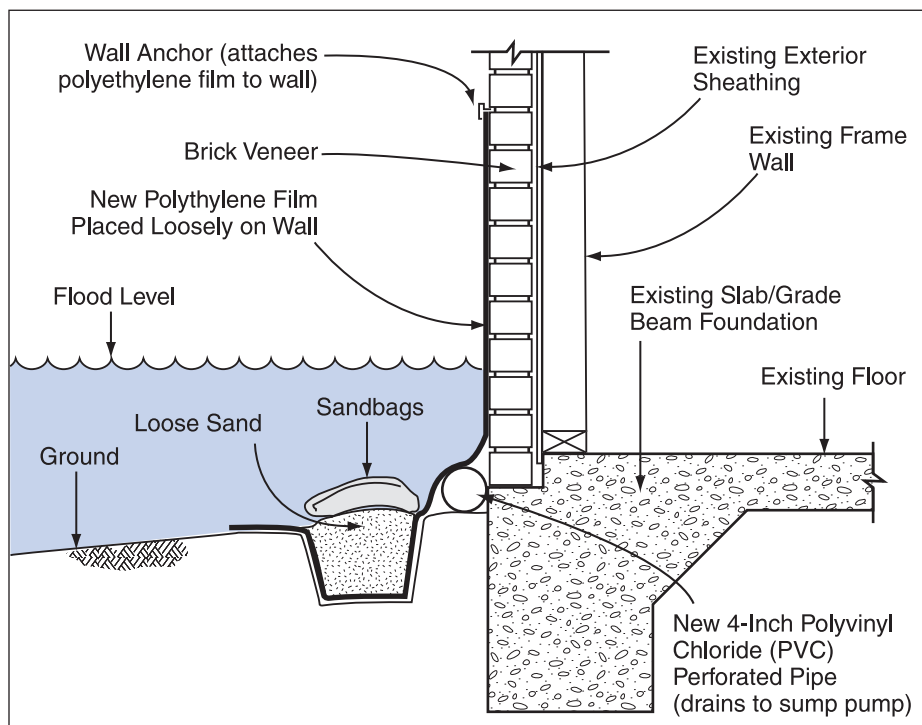

Figure 7-9. In the “wrapped home” method, the lower portion of the home is protected with a temporary layer of polyethylene film. As shown, a temporary drainage line is also required.

Because the wrapped home technique is only temporary, it does not change the normal appearance of your home. However, like any temporary technique, it requires extensive human intervention. All the necessary materials must be immediately available, and it will usually take four to six people several hours to put them into place. Therefore, you must have adequate warning every time flooding threatens so that you can install both the film and drainage system.

Commercial versions of the wrapped home technique are available. Usually, they consist of a system of vinyl-coated nylon wrapping mounted on rollers, which are contained in boxes

permanently installed in the ground around the perimeter of the home. To protect the home, you open the boxes, pull the material out, and attach it to hooks or clips mounted on the walls of the home. The primary advantages of these commercial systems are that they provide a stronger barrier and allow for a shorter installation time. However, commercial home wrapping systems do not, by themselves, strengthen the walls of a home; if depths greater than 3 feet are expected, the walls must be adequately reinforced. Also, these systems do not eliminate the need for adequate drainage lines and sump pumps.

Shields

Shields are flood barriers placed over openings in walls such as doorways and windows. Shields can be made of any of several materials, depending on the size of the opening to be covered, and should include a gasket along the edge of the shield. When flood depths are expected to reach the maximum allowable 2 to 3 feet, shields for openings wider than approximately 3 feet must be made of strong materials such as heavy-gauge aluminum or steel plate (Figure 7-10); shields for lesser depths and smaller openings can be made of lighter materials.

Figure 7-10. Heavy-gauge metal shield over sliding glass door opening.

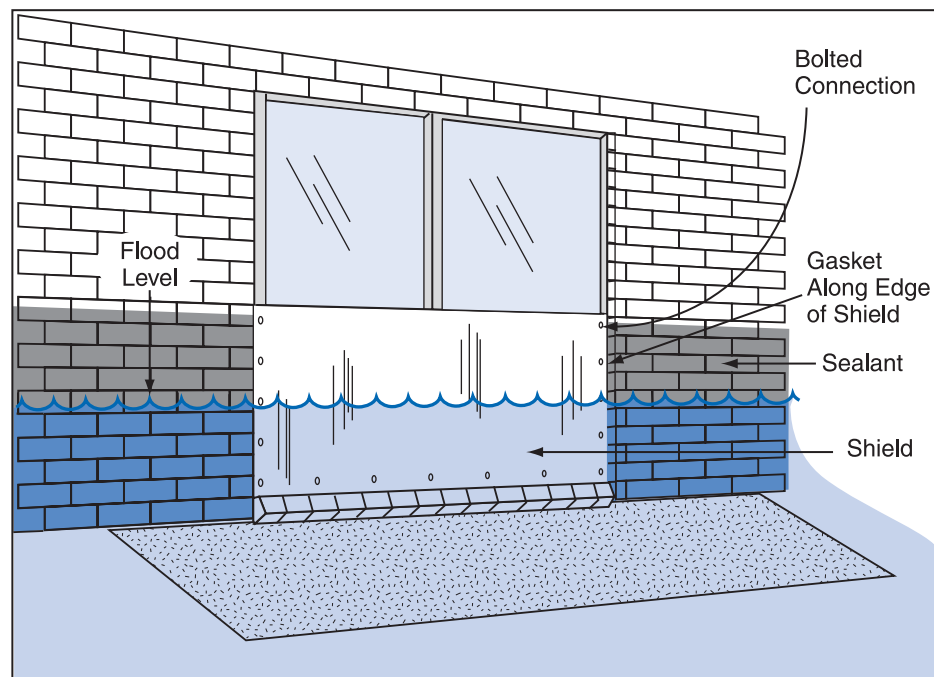

Because permanently blocking all doors and other openings would be impractical, shields are usually placed temporarily, after flood warnings are issued. Smaller, lighter shields can be stored in the home and, when needed, brought out and bolted in place or secured in permanently installed brackets or tracks (Figure 7-11). Larger, heavier shields may have to be permanently installed on hinges or rollers so that they can be opened and closed easily.

Companies that specialize in flood protection devices can provide custom-fitted flood shields. Usually, these commercial shields are made of heavy-duty materials, and some are equipped with inflatable or other types of gaskets that help prevent leaks.

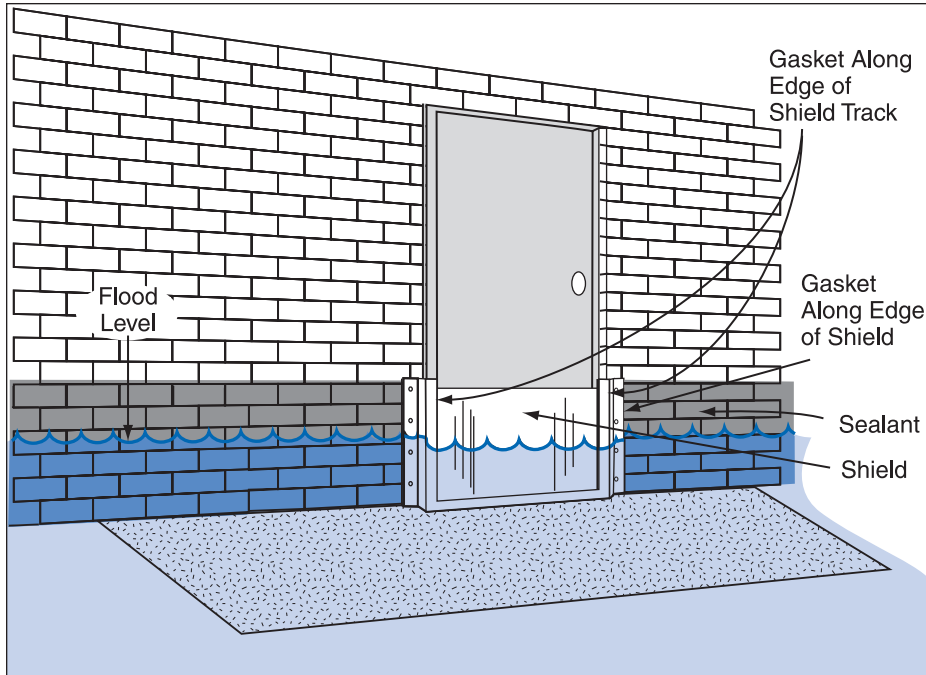

Figure 7-11. Light-gauge metal shield held in place by permanently installed tracks.

An alternative to using shields is to permanently seal openings. For example, a low-level window can be removed or raised and the opening bricked up or filled with glass block (Figure 7-12).

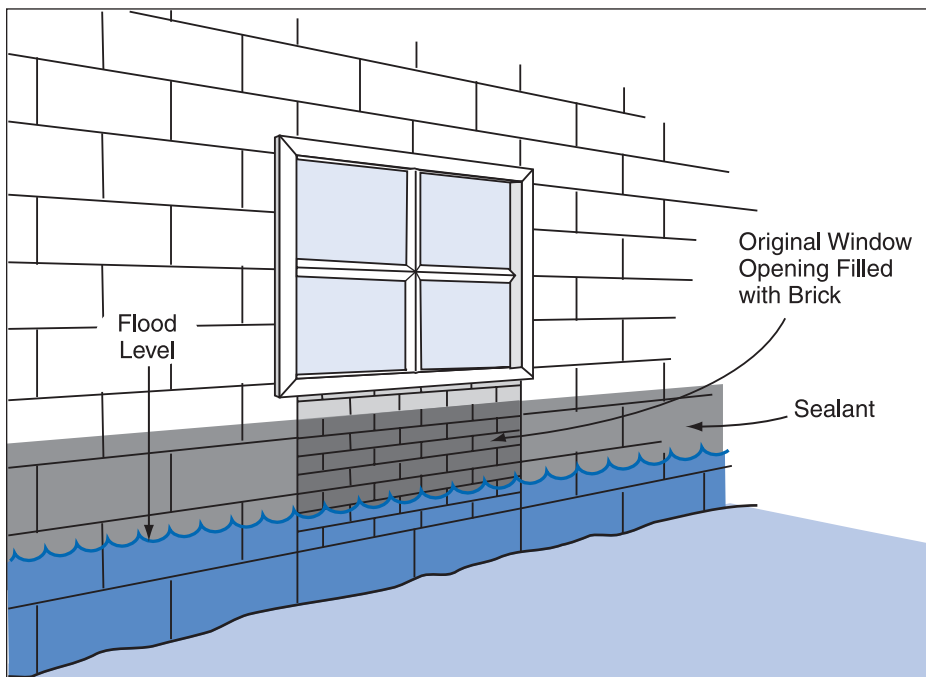



Figure 7-12. Low window raised approximately 2 feet and original opening filled with brick.

Drainage Systems

Sealants and shields provide the bulk of the protection in dry floodproofing, but they may permit some leakage, especially during floods of longer duration and when damaged by debris. They also do not protect against “**underseepage**” – water that migrates downward along the sealed wall and then under the foundation. For these reasons, a dry floodproofed home must have a drainage system that will remove any water that enters the home through leaks in sealants and shields and any water that accumulates at the base of the foundation. Depending on the permeability of the soils around and under the home, the drainage system may also have to be designed to reduce buoyancy forces.



DEFINITION

Underseepage refers to water that migrates downward along the sealed walls of a home and then under the foundation.

An adequate drainage system includes drains along the base of the foundation and under the floor. The drains consist of perforated pipe surrounded by crushed stone. The pipes collect water that seeps through the ground and channel it to a central collection point equipped with a sump pump. This system is shown in Figure 7-13. The sump pump must have sufficient capacity to handle the inflow of water and must have an emergency power source, such as a portable generator, so that it will continue to operate if conventional electric service is disrupted.

Figure 7-13. Drainage system for a dry floodproofed home.

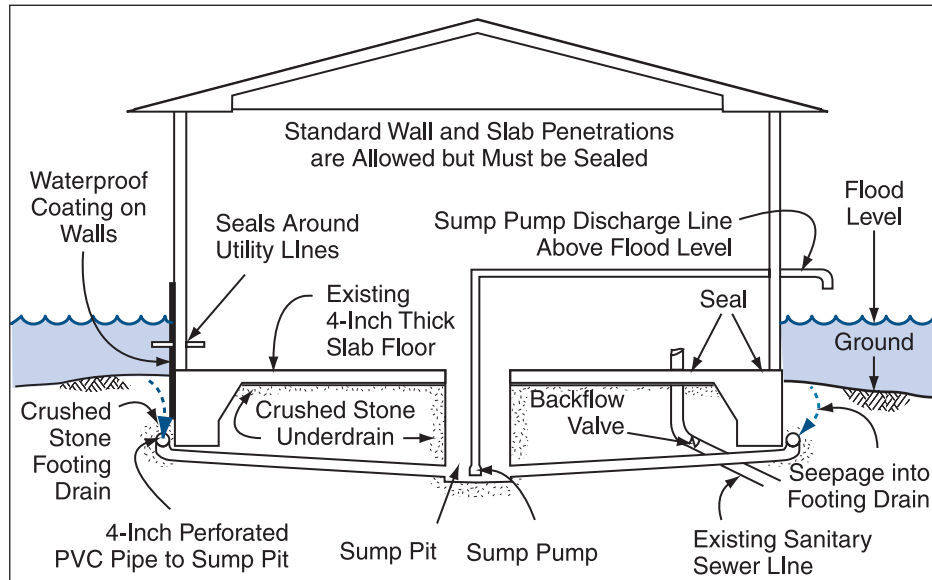

Protecting Service Equipment

Dry floodproofing a home will not protect service equipment outside the home. Examples of service equipment normally found outside the home are utility lines, air conditioning compressors, heat pumps, and fuel storage tanks. Chapter 8 discusses the protection of service equipment.

7.4 Levees and Floodwalls



7.4.1 Introduction

Levees and floodwalls are both barriers that hold back floodwaters, but they differ in their design and construction, appearance, and application. Levees are embankments of compacted soil. They usually have rounded outlines and can be blended into the natural landscape of the home site. Floodwalls are structures built of manmade materials, such as concrete and masonry. Although they cannot be made to look like a natural landscape feature, they can be designed and constructed in such a way that they complement the appearance of the home and its site.

A levee requires more land area than a floodwall of comparable height; therefore, for small lots levees are less practical than floodwalls. Floodwalls, because of their design, construction, and more efficient use of space, not only can be built on smaller lots but also can be used selectively in conjunction with other retrofitting methods. For example, you can build a small exterior floodwall to protect an individual window or door in the wall of a dry floodproofed home. You can protect a walkout-on-grade basement by building a floodwall that ties into the ground where the grade rises above the flood elevation on the sides of the home. This approach is illustrated in Table 3-14, in the sample cost estimate for levees and floodwalls. You can also build an interior floodwall to protect service equipment in the basement of a wet floodproofed home (see Chapter 8).

There are currently thousands of miles of levees across the country that affect millions of people, and it is important to understand the risks associated with living behind levees. Levees and floodwalls are designed to provide a specific level of protection, and larger flood events can cause them to be overtopped. Levees and floodwalls require regular maintenance and periodic upgrades to ensure that they retain their level of protection and continue to perform as intended.



WARNING

Levees and floodwalls cannot be used to bring a substantially improved or substantially damaged home into compliance with the requirements of your community's floodplain management ordinance or law.



NOTE

Always use a licensed, bonded, and insured contractor for levee and floodwall projects. Ensure that your contractor has experience designing and constructing levees and floodwalls and understands the considerations discussed in Section 7.4.2.

If you decide to build a levee or floodwall on your property, you must consult with your local official to make sure it is allowed under your local floodplain ordinance. You should then consult a licensed professional engineer and work with licensed contractors to ensure that the levee or floodwall meets current design, operations, and maintenance criteria. Individual residential levees or floodwalls cannot be used to bring a home with a first floor elevation below the BFE into compliance with the NFIP.

Your property may be protected by an existing levee. A levee that protects your property may be owned by your local or State government or a Federal agency such as the USACE.

For more information about levees in your area, you can:

- Check your current FIRM to see if a levee or floodwall is already shown on the map as providing protection against the 1-percent annual chance (100-year) flood (see Section 2.6.2 for information about obtaining FIRMs)
- Call your local officials to request information about levees in your area (see Appendix D for your State NFIP coordinator)
- Check with your USACE office about any federally owned levees in your area (contact information is available at <http://www.usace.army.mil/ContactUs/Pages/PageWithZones.aspx>)
- Check FEMA's website at http://www.fema.gov/plan/prevent/fhm/lv_intro.shtm to learn more about levees

7.4.2 Considerations

Levee or Floodwall Height

The height of your levee or floodwall will be determined partly by the DFE you have chosen. However (as explained in Chapter 3), height limitations imposed by design complexity, construction cost, and property space requirements, coupled with the need to provide at least 1 foot of freeboard, usually restrict the use of residential levees and floodwalls to areas where flood depths are no greater than 5 feet and 3 feet, respectively. If the flood depths at your home are greater, you should consider an alternative retrofitting method, such as elevation (Chapter 5), relocation (Section 7.2), or demolition (Section 7.5).

Remember that no matter what the height of a levee or floodwall, it can always be overtopped by a flood higher than expected. Overtopping allows



WARNING

Your community's floodplain management ordinance or law may prohibit the construction of levees and floodwalls in the regulatory floodplain and floodway. If you are unsure about your community's requirements or the location of your property in relation to the floodplain and floodway, check with your local officials. See Section 2.6.2 for information about the floodway.

water into the protected area, and the resulting damage to your home will probably be just as great as if it were not protected at all.

Safety and Security

Overtopping is a bigger problem for a levee than a floodwall. Even a small amount of overtopping can erode the top of a levee and cause the levee to fail. When this occurs, large amounts of water may be released at once and cause even greater damage to your home. When floodwaters threaten to overtop a levee, you may be able to raise the top of the levee temporarily with sandbags, but increasing the height of a levee increases the pressure of floodwaters on it and may cause the levee to fail.



WARNING

Because levees and floodwalls can push water onto other properties, you may find that local zoning regulations prohibit or restrict their use. Special permits may be required.

An important consideration for both levees and floodwalls is that they can give the homeowner a false sense of security. Every flood is different, and one that exceeds the height of your levee or floodwall can happen at any time. For this reason, you must not occupy your home during a flood.

Effect on Other Properties

A particularly important design consideration is the effect that a levee or floodwall can have on other properties. These barriers can divert floodwaters away from your home and onto other properties. They can also impede or block flood flows. As a result, they can cause water to back up into previously flood-free areas or prevent natural surface drainage from other properties.

Levee and Floodwall Size

Levees are earthen structures that rely on their mass to resist the pressures of floodwaters. To provide structural stability and resist erosion and scour, the sides of a levee are sloped – the width of the levee at its base is usually 6 to 8 times its height (see Figure 7-14a). As a result, the taller a levee is, the more space it requires. Most floodwalls do not rely solely on their mass for resistance to flood pressures. Therefore a floodwall will require less space than a levee of the same height, as shown in Figure 7-14b.

Soils

Most types of soils may be suitable for constructing residential levees. The exceptions are very wet, fine-grained, or highly organic soils. These soils are usually highly **permeable**. The best soils are those that have a high clay content, which makes them highly **impervious**. Using impervious soils for the levee and its foundation minimizes the seepage of water through or under the levee. Excessive seepage can weaken the levee and cause it to fail. If a sufficient amount of

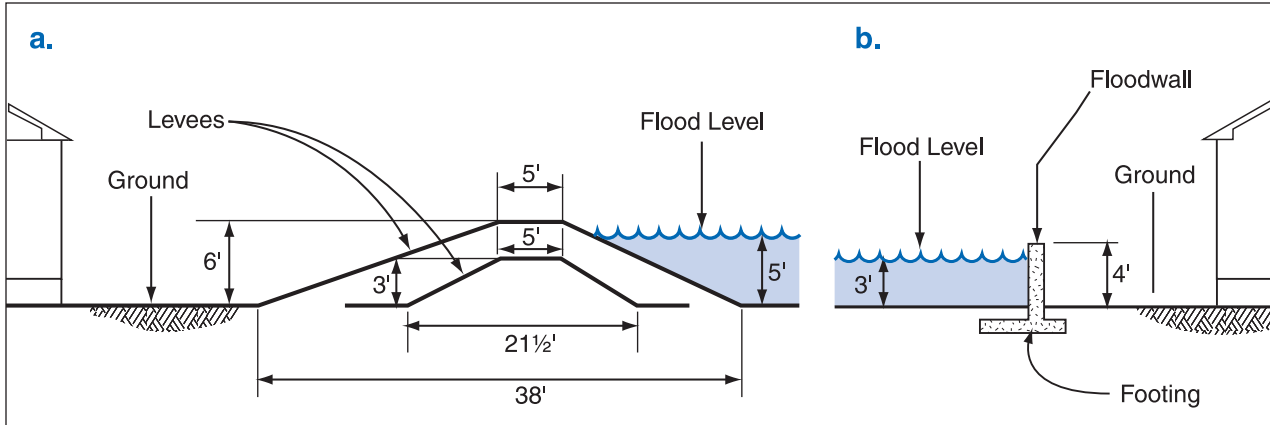

Figure 7-14. Cross-sections of a typical 3-foot high levee, 6-foot high levee, and 4-foot high floodwall. A 4-foot high floodwall (b) requires much less property space than a 3-foot high levee (a).

adequate soil is not available at the site of your home, the soil will have to be brought to the site or the levee design will become more complex. In either situation, the levee will be more expensive to build.

Soil type is an important consideration in floodwall construction as well. The soil under the floodwall, like that under a levee, must resist seepage. If the soils under a floodwall become saturated, the floodwall will no longer be adequately supported. As a result, the pressure of floodwaters can cause it to lean or overturn.

Hydrostatic Pressure

Levees and floodwalls are designed to resist flood forces, but they may not be able to protect a home from hydrostatic pressure. The migration of moisture through the ground below a levee or floodwall, as a result of seepage or the natural capillary action of the soil, can cause the soil in the protected area to become saturated (Figure 7-15). If this saturated soil is in contact with the foundation of the home, the resulting hydrostatic pressure can buckle slab floors, push homes up, and cause basement walls to bulge inward or collapse. If you plan to protect your home with a levee or floodwall, especially if you have a basement, your design professional should determine the potential hazard from hydrostatic pressure and take whatever steps may be necessary to protect against it.



DEFINITION

Permeable soils are those that water can easily penetrate and flow through. **Impervious soils** are the opposite. They resist penetration by water.



NOTE

You can usually get information about soil types from local officials, the agricultural extension services of State universities, and regional offices of the NRCS of the USDA.

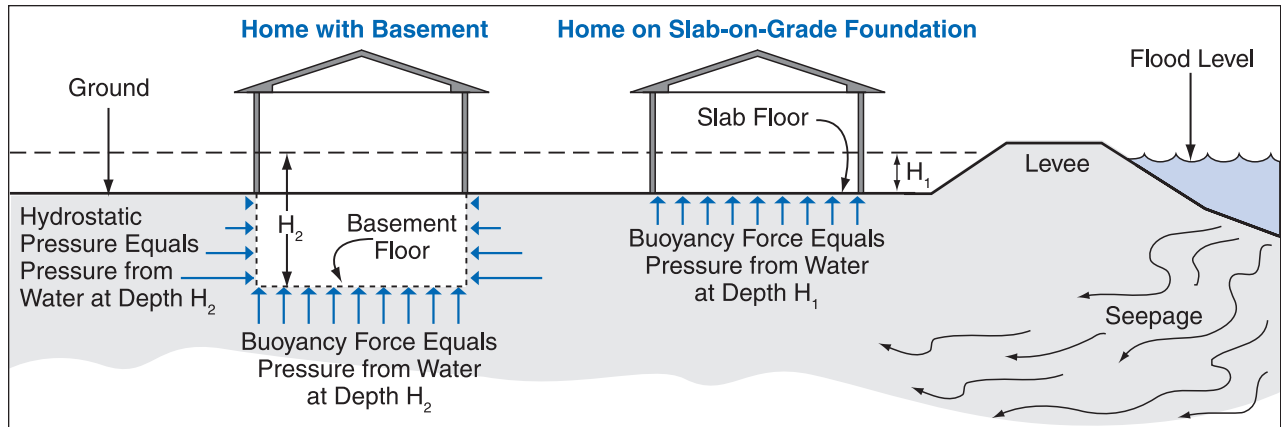

Figure 7-15. Hydrostatic pressure in saturated soils poses a threat to homes behind levees, especially homes with basements. The amount of pressure depends largely on the level of the home in relation to the level of the water on the flooded side of the levee. The higher the water level is above the lowest floor of the home (as shown here by depths H_1 and H_2), the greater the pressure.

Methods of reducing the risk of damage from hydrostatic pressure include moving the flood-wall or levee farther away from the home, installing a foundation drain system (drains and sump pump), and filling in basements with dirt.

Flood Conditions

Levees are most effective against floods that have low flow velocities and durations of no more than 3 to 4 days. High-velocity flows can erode or scour the sides of a levee and possibly cause it to collapse. Levees can be protected from erosion and scour in several ways. The sides of all levees should be stabilized with grass, which helps hold the soil in place. The sides of levees that will be subjected to higher-velocity flows can be armored with concrete or broken rock. Aligning a levee so that it is parallel to the flow of water will also help protect it from erosion and scour, and reducing the angle of the side slopes will make the sides more resistant to scour. Where the duration of flooding is expected to exceed 3 to 4 days, a levee may not be the most appropriate retrofitting measure. When levees are exposed to floodwaters for prolonged periods, seepage and the problems associated with it are more likely to occur.

Access and Closures

Levees and floodwalls can block access to your home. If you build a levee or floodwall, you will usually need to provide openings or other means of access for driveways, sidewalks, and other entrances, but any opening in a floodwall or levee must be closed when flooding threatens. A variety of closure mechanisms are available. For floodwalls these include shields similar to those used in dry floodproofing (as described in Section 7.3.2) that are hinged to the wall or designed to slide into place. Prefabricated panels stored elsewhere when not in use are also acceptable (Figure 7-16). Acceptable closures for levees include permanently mounted, hinged, or sliding flood gates and prefabricated stop logs or panels.

Figure 7-16. Closure panels for floodwalls.

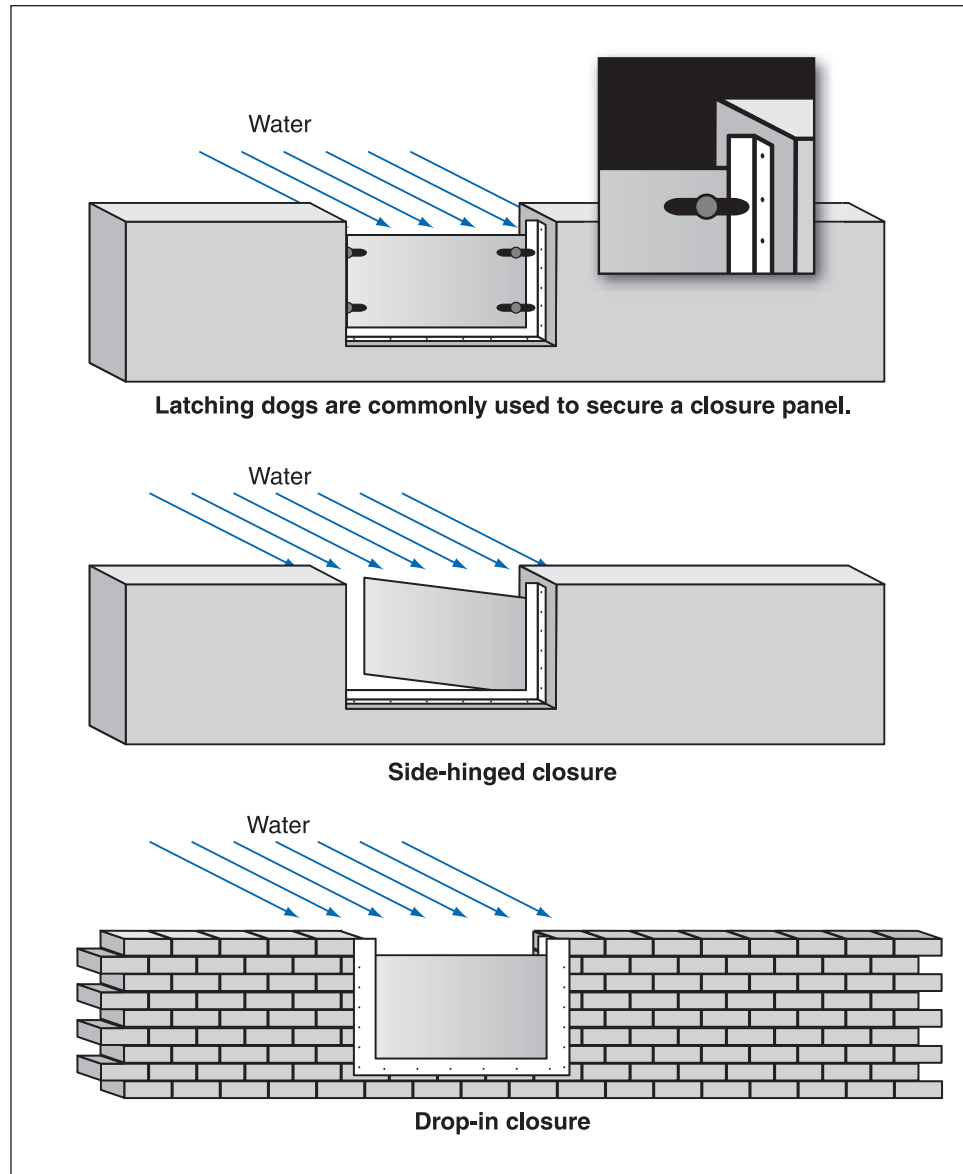

An alternative to incorporating openings is to provide a means of crossing over the top of a levee or floodwall. If a levee is low enough, a ramp can be created with additional fill material. Similarly, a stairway can be built over a low floodwall, as shown in Figure 7-17.

Interior Drainage

Building a levee or floodwall around a home keeps floodwater out of the protected area, but it can also keep water in – water that collects from rain or snow and from seepage during floods or, in the worst case, water that overtops the levee or floodwall. Two methods of removing this water should be used for all levees and floodwalls: drains and sump pumps. Drains installed at the base of a levee or floodwall allow collected water to flow out of the protected area. The outlets of the drains must be equipped with flap valves that close automatically during flooding to prevent floodwater from backing up through the drains into the protected area.

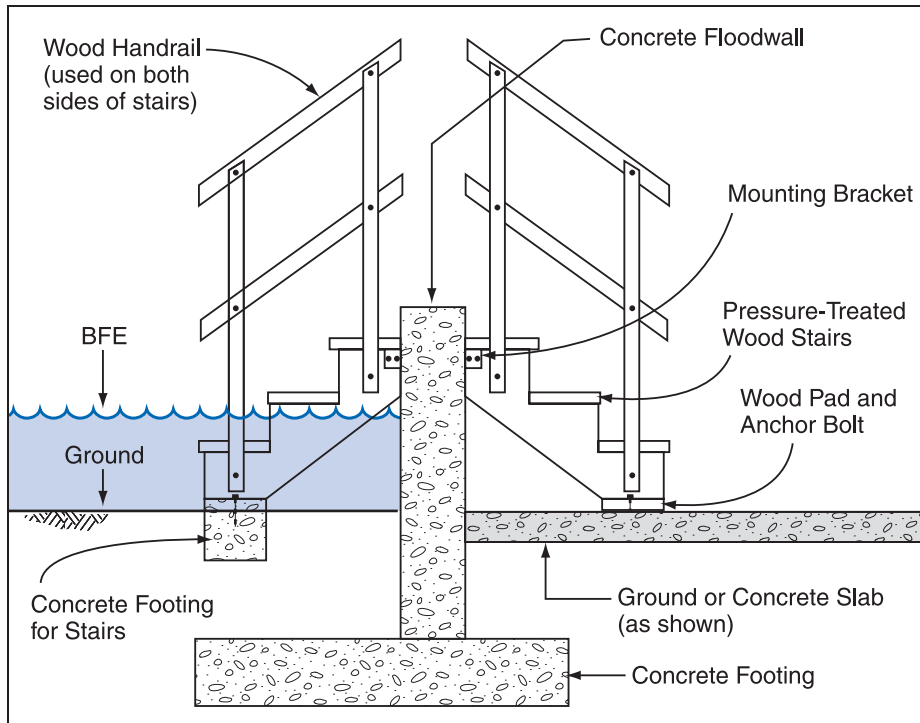

Figure 7-17. An access staircase over a low floodwall.

An electric sump pump should be installed at the lowest point inside the protected area. The pump must have an adequate capacity – it must be able to remove water from the protected area faster than water enters. An emergency power source, such as a gasoline-powered generator, should be provided so that the pump will continue to operate during interruptions in electrical service, a common event during a flood. Whenever possible, the downspouts from the roof of the home should be directed over the levee or floodwall so that they will not contribute to the collection of water in the protected area.

Inspection and Maintenance

After a levee or floodwall is constructed, you must inspect it periodically and make whatever repairs are necessary. Otherwise, small problems (e.g., settlement, cracking, loss of vegetation, and minor amounts of erosion and scour) can quickly become major problems during a flood. At a minimum, you should perform these inspections each spring and fall, before each impending flood if you have adequate warning, and after each flood. In addition, closure mechanisms should be inspected to ensure shields are accessible and gaskets have not deteriorated.

Protecting Service Equipment

Protecting a home with a levee or floodwall also protects any service equipment inside the home. When levees and floodwalls protect not only the home but an area around it as well, service equipment mounted on exterior walls, such as an electric meter, and equipment installed near the home, such as an air conditioning compressor, will be protected. But any equipment outside the protected area must be relocated, elevated, or anchored. Chapter 8 discusses the protection of service equipment.

7.4.3 Levee Construction

The design professional must conduct an analysis of the soil at the site to determine whether it is adequate for use in the levee and to anticipate any foundation and seepage problems. When you construct a levee, you should try to take advantage of the natural terrain around your home. Depending on the topography of your lot, the levee may not have to completely encircle your home. You may be able to build the levee on lower ground and tie the ends into higher ground. An advantage of this technique is that the levee can often be made to look like part of the natural topography of your lot.

In preparation for construction, all ground vegetation and topsoil should be removed from the levee site. Sod should be set aside so that it can be used on the surface of the levee after construction. The levee should be built up in 6-inch layers, each of which must be compacted.

If there is a shortage of impervious soils in the area, the levee can be built with an impervious core and the available permeable soils can be used for the outer part of the levee, as shown in Figure 7-18. The core can be made of impervious soils or another type of water-resistant barrier. Above ground, the impervious core should extend the full height of the levee and be at least as wide as the width of the levee at the top. Below ground, the impervious core should extend at least 4 feet below the base of the levee and be at least 2 feet wide. The core will minimize seepage through the levee; however, the use of permeable soils on the outside of the levee will require that the angle of the side slopes be reduced so that erosion and scour are minimized. This is an important consideration when property space is limited, because reducing the angle of the side slopes will increase the width of the levee base.

Figure 7-18. Levees are constructed with compacted layers of soil. When an adequate amount of impervious soil is not available, the levee can be constructed of permeable outer soils and an impervious core.

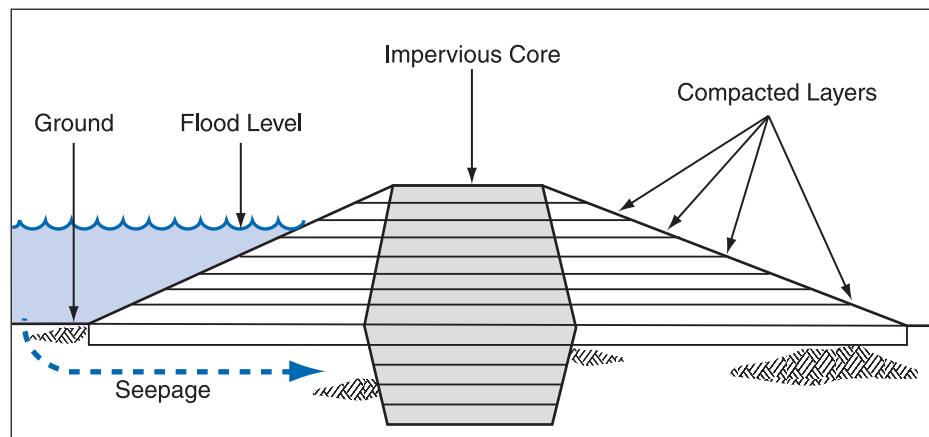

If the soil underlying the levee is highly permeable, an impervious barrier may have to be constructed below the levee to control foundation seepage. Several types of barrier designs are available, but they are normally used for major levee projects and would usually be too expensive for a homeowner. The analysis of the soil at the site will reveal such problems.

As noted earlier, the height of the levee will depend on the DFE and the need for at least 1 foot of freeboard. Also, the levee should be built at least 5 percent higher than the desired

elevation. This additional height will compensate for settlement of the soil that occurs naturally after construction.

7.4.4 Floodwall Construction

The design professional must perform a soils analysis similar to that performed for levee construction. The purpose is to determine whether the soils will support the floodwall and whether seepage or migration of water through the soil will be a problem.

Construction, which begins with excavation for the foundation, varies according to the type of wall. The two main types of floodwalls are gravity walls and cantilever walls (Figure 7-19). Both types resist overturning, which is the most common cause of floodwall failure, and displacement, but they do so in different ways.

The gravity floodwall relies on its weight and mass, particularly the mass at its base, for stability. The sheer weight of the materials used in its construction (usually solid concrete, alone or in combination with masonry) make it too heavy to be overturned or displaced by flood forces. Gravity floodwalls are relatively easy to design and construct. However, the size of the wall increases significantly with height so, as flood depths increase, a cantilever floodwall becomes more practical.

A cantilever floodwall consists of a wall and footing constructed of cast-in-place concrete (similar to a foundation wall and footing for a home). The cantilever floodwall relies partly on the weight of the floodwater and soil for stability. As shown in Figure 7-19, the “heel” of the wall (the portion of the footing on the flooded side) extends farther than the “toe” (the portion of the footing on the protected side). Through leverage, the pressure of water and soil on the heel helps counteract the overturning force of the floodwater. Reinforcement of a cantilever wall consists of steel bars embedded in the concrete.

Both masonry and cast-in-place cantilevered floodwalls can be faced with brick or stone or receive other decorative treatments that match or complement the exterior walls of a home (Figure 7-20). If your floodwall is connected to your home, as shown in Figure 7-20, it is critical to ensure that the connection between the floodwall and the home is tightly sealed.



NOTE

A reinforced cast-in-place wall with a foundation at the proper depth provides an excellent barrier to seepage because it is constructed of a single, solid, water-resistant material. The reinforcement not only gives the wall strength to resist the pressure of floodwaters, but helps it resist cracking.



WARNING

Occasionally, floodwalls are built with a core of concrete block and a facing of brick. Even though the blocks are grouted, reinforced, and filled with concrete, experience has shown that this type of wall is neither as strong nor as resistant to leakage as cast-in-place concrete walls.

Figure 7-19. Gravity and cantilever floodwalls.

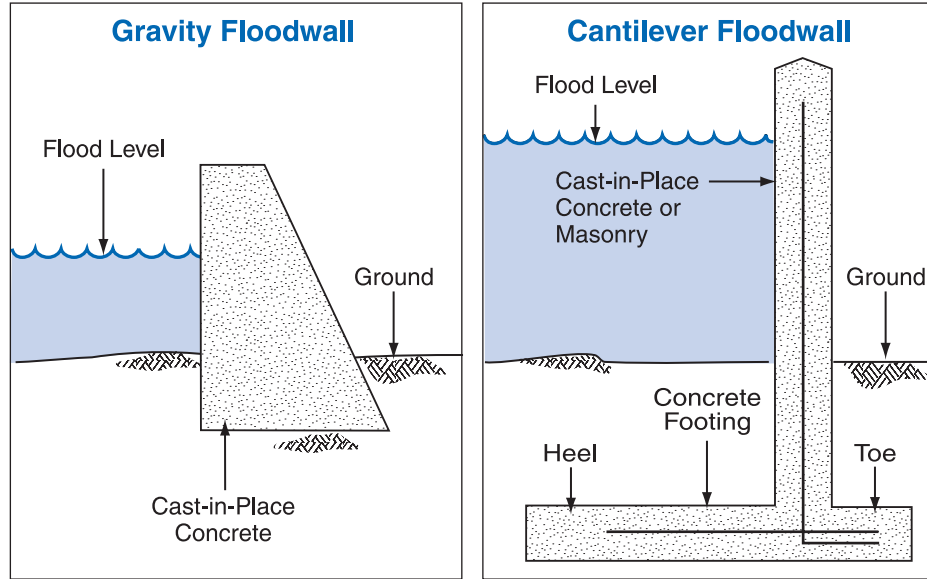
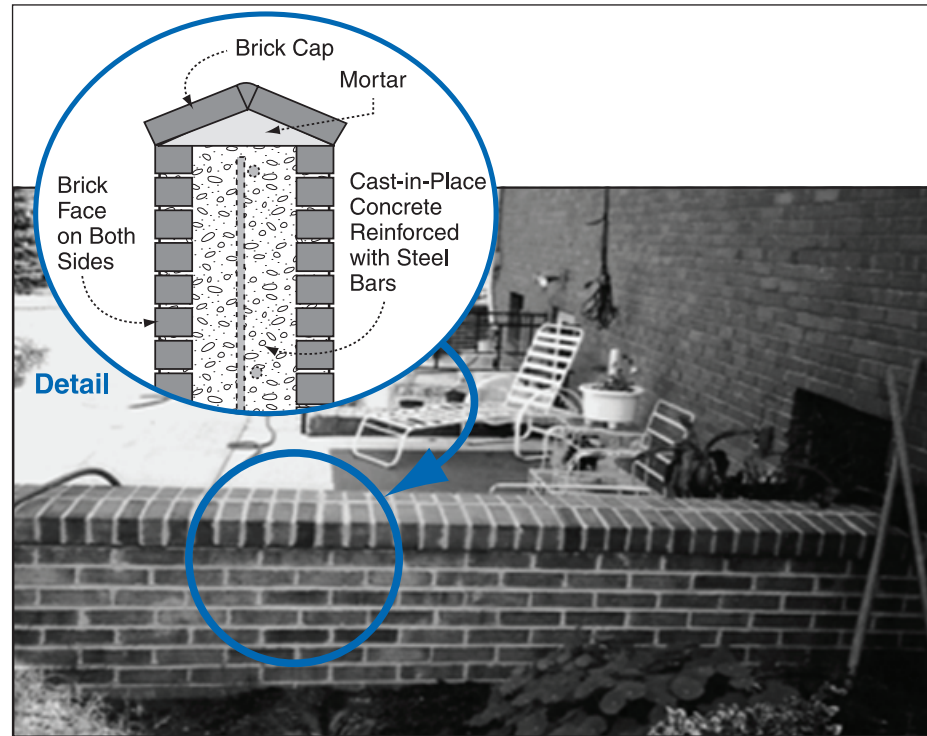

Figure 7-20. Typical brick-faced concrete floodwall. Detail shows cross-section through wall.



7.4.5 Temporary Flood Barriers

Temporary flood barriers use the same principles as permanent barriers such as floodwalls or levees, but can be removed, stored, and reused in future flood events. Historically, temporary barriers such as sandbags have been commonly used to fill openings or reinforce existing permanent barriers. However, in recent years, many newer temporary flood barrier products and systems have been developed to take the place of sandbag floodwalls and may also be used to reinforce existing permanent barriers or even create a new barrier. These new products include

water-filled barriers or metal floodwalls designed so that they can be quickly installed and used numerous times.

In 2002, the Association of State Floodplain Managers (ASFPM) began working with the U. S. Army Corps of Engineers' National Nonstructural Flood Proofing Committee (NFPC) and other stakeholders to establish a national testing and certification program for temporary flood barriers. Over time, FM Approvals (a division of FM Global Insurance) developed an approval system for recognizing temporary barriers as flood abatement equipment for their insured customers. In 2006, FM Approvals distributed FM Approval Standard 2510, *Flood Abatement Equipment* (<http://www.fmglobal.com/assets/pdf/fmapprovals/2510.pdf>), which provides approval requirements for temporary flood barriers that protect against riverine flooding to a depth of 3 feet.

7.5 Demolition



7.5.1 Introduction

If a flood-prone home has been severely damaged, because of flooding or any other cause, demolition can be practical and effective. Demolition may also be practical for an undamaged home that, because of deterioration over time or for other reasons, is not worth retrofitting with any of the other methods described in this guide. If you choose demolition, you will tear down your damaged home and either rebuild a compliant home on the same property or move elsewhere, outside the floodplain. If you decide not to rebuild, your State or local government may buy or **acquire** your property. Depending on your choice of a site for your new home, this method can lower or even eliminate your flood insurance premiums. If you decide to rebuild, your **mitigation reconstruction** project may be eligible for FEMA grant money (see Section 2.7.1).

The demolition process involves disconnecting and capping utility lines at the damaged home, tearing the home down, removing debris and otherwise restoring the old site, and building or buying a new home. The most important



NOTE

Always use a licensed, bonded, and insured contractor for demolition projects and for reconstruction projects. Be sure that your contractor has experience with demolition (and construction for mitigation reconstruction) and understands the considerations discussed in Section 7.5.2.



DEFINITION

Acquisition is the process by which your State or local government purchases your flood-prone property, demolishes the building, and maintains the land as an open space.

Mitigation reconstruction is the construction of an improved, elevated building on the same site where an existing building and/or foundation has been demolished. Mitigation reconstruction is only permitted if traditional structure elevation cannot be implemented.

considerations involve how badly your home has been damaged and your options for building or buying a new home.

7.5.2 Considerations

Amount of Damage

Demolition is more practical for severely damaged homes than for those with little or no damage. If a flood, fire, earthquake, hurricane, or other disaster has caused extensive damage to the interior and exterior of your home or left it structurally unsound, you will probably find that tearing the home down and starting over is easier than making all of the necessary repairs. Also, remember that a severely damaged home in the regulatory floodplain will almost surely be considered substantially damaged under your community's floodplain management ordinance or law. Salvaging such a home would require not only repairing the damage but also elevating (including filling in a basement); wet floodproofing areas used only for parking, building access, or storage; or relocating the home as described in Section 7.2.

Rebuilding or Buying Another Home

Tearing down a home is the easy part of the demolition process. You must also buy or build another home elsewhere or rebuild somewhere on your existing property. Regardless of your decision, your goal is to greatly reduce or eliminate the potential for damage from floods, earthquakes, high winds, and other hazards. If you buy or build a home elsewhere, you'll want to find a site that is outside the regulatory floodplain, ideally one that is well above the BFE. You should also consider the other hazards mentioned above. Check with your local officials about this before you make your final decision.

When you buy or build a home elsewhere, you need to think about what you will do with your old property. Property that is entirely within the regulatory floodplain may be difficult to sell because of restrictions on its use. As explained in Section 2.7, some Federal programs provide grants to States and communities that they can use to buy flood-prone homes and properties. State and local programs may also provide financial assistance. Check with your local officials about this.

When buying or building a home elsewhere is too expensive, you may be able to rebuild on your existing property, either on the site of your old home or, preferably, on a portion of your property that is outside the regulatory floodplain. If you rebuild on the site of your old home, your community's floodplain management ordinance or law will require that the lowest floor be at or above the BFE. How you can meet this requirement depends on the flood zone and code requirements of your community. An important disadvantage of this approach is that you may not have access to your home during floods.

If your existing property includes a large enough area outside the regulatory floodplain, a better choice is to rebuild there. Building outside the floodplain gives you greater freedom to build

the type of home you want. Also, because both the home and property are outside the floodplain, restricted access during flooding is less likely to be a problem.

Disruption of Occupants

Like relocation, demolition can be disruptive for the occupants of the home. Unless you decide to buy an existing home elsewhere, you must find a place to live and to store your furniture and belongings while your new home is being built.

Permitting

You or your design professional or contractor must check with local officials regarding permitting requirements for the necessary work. All permits for demolition should be obtained before the demolition process begins, including disconnecting and capping utilities, disposing of debris, new construction, and restoration of the old site.

7.5.3 The Demolition Process

Tearing Down the Old Home

Your utility companies must first turn off all services to the home. Your demolition contractor will then disconnect the utility lines. If you do not plan to rebuild on the same site, the contractor will cap the lines permanently or remove them according to the requirements of the utility companies. Before demolition begins, environmental hazards, such as asbestos, must be abated in accordance with Federal, State, and local requirements. Normally, a demolition contractor will bulldoze the home and then dispose of the resulting debris as required by Federal, State, and local regulations.

Restoring the Old Site – Acquisition

If you are not rebuilding on the old site, it must be restored according to the requirements of local regulations. Site restoration usually involves demolishing and removing not only the home, but also any pavement, such as a driveway or patio; grading to restore areas disturbed by the demolition; and stabilizing the site with grass.

If your old site included a septic tank or fuel storage tank, you may have to meet the requirements of environmental regulations aimed at preventing contamination of the groundwater. You may be required to drain and remove aboveground and underground storage tanks (ASTs and USTs), or you may have to anchor them to resist flotation. You may also be required to test the soil around an UST to determine whether leakage has occurred. As the homeowner, you will usually be responsible for cleaning contaminated soil if there has been any leakage from the tank. In this situation, you will need the services of a qualified geotechnical or environmental engineering firm.

Local utility companies or regulatory officials can inform you about requirements concerning capping, abandoning, or removing various utility system components.

Rebuilding – Mitigation Reconstruction

Your construction contractor will prepare the site and build your new home according to the local building code, floodplain management, and zoning requirements. Therefore, the lowest floor of your new home must be at or above the BFE, and you will not be allowed to build a home with a basement. Figure 7-21 shows a mitigation reconstruction project that was recently completed in Louisiana following Hurricane Katrina.

Depending on where you decide to rebuild, local utility companies may have to extend new lines into the site of your new home. Usually this is done before construction is completed. Your contractor will hook up the utility lines as part of construction. You may need the services of a design professional if specialized utility systems are required because of the location of your site, the type of home you decide to build, or the nature of the hazards at the site.



WARNING

If you rebuild on the site of your old home, your community's floodplain management ordinance or law will not allow you to have a basement below the BFE.

Figure 7-21. Typical mitigation reconstruction project.



8.0 Protecting Service Equipment

8.1 Introduction

Homes are typically provided with a variety of building support service equipment. The five major utility systems found in most homes are:

- Heating, ventilating, and cooling (HVAC) systems, including air conditioning compressors, heat pumps, furnaces, ductwork, and hot water heaters
- Fuel systems, including natural gas lines and fuel storage tanks
- Electrical systems, including wiring, switches, outlets, fixtures, and fuse and circuit breaker panels
- Sewage management systems, including sewer lines, drains, septic tanks, and drainage fields
- Potable water systems, including water lines, private wells, and storage tanks

Most homes also have communications systems, including telephone, internet, and cable television lines.

Some utility equipment is normally found inside a home (e.g., furnaces, ductwork, water heaters, and appliances) and some is found outside (e.g., propane tanks, air conditioning and heat pump compressors, heat pumps, and septic tanks). Other utility equipment includes components found both inside and outside a home (e.g., electrical systems; plumbing, gas, telephone, and cable TV lines; and oil storage tanks).

The original placement of service equipment in and around your home was probably based on standard construction practices and the economic concerns of the builder. As a result, in flood-prone homes, service equipment is often installed in areas where it will be exposed to floodwaters, such as in a basement or crawlspace or at ground level outside the home.

Elevation, wet floodproofing, and dry floodproofing protect the structure of your home from damage by floodwaters. But these methods, unlike relocation and the construction of levees or



NOTE

For more information about elevating electrical and HVAC systems, refer to FEMA 348, *Protecting Building Utilities from Flood Damage* and FEMA 499, Fact Sheet No. 29: *Protecting Utilities*.

floodwalls, do not prevent floodwaters from reaching the home. For this reason, protecting service equipment located below the expected flood level is an essential part of a retrofitting project.

8.2 Methods of Protection

You can protect interior and exterior service equipment in three ways: by elevating it, relocating it, or protecting it in place. More information on these methods can be found in FEMA 348, *Protecting Building Utilities from Flood Damage*.

8.2.1 Elevation

Service equipment installed outside your home can usually be elevated above the flood level. Equipment mounted on an exterior wall (e.g., an electric meter and incoming electric, telephone, and cable TV lines) usually can be mounted higher up on the same wall. Equipment normally placed on the ground (e.g., air conditioning compressors and heat pumps) can be raised above the flood elevation on pedestals or platforms (Figures 8-1 and 8-2).



NOTE

Some utility companies have requirements for ensuring their meter readers can access the meters for reading, such as providing stairs to a platform under the reader. Check with your service provider before elevating service equipment.

Figure 8-1. Air conditioning/heat pump compressor mounted on a brick pedestal outside an elevated home.

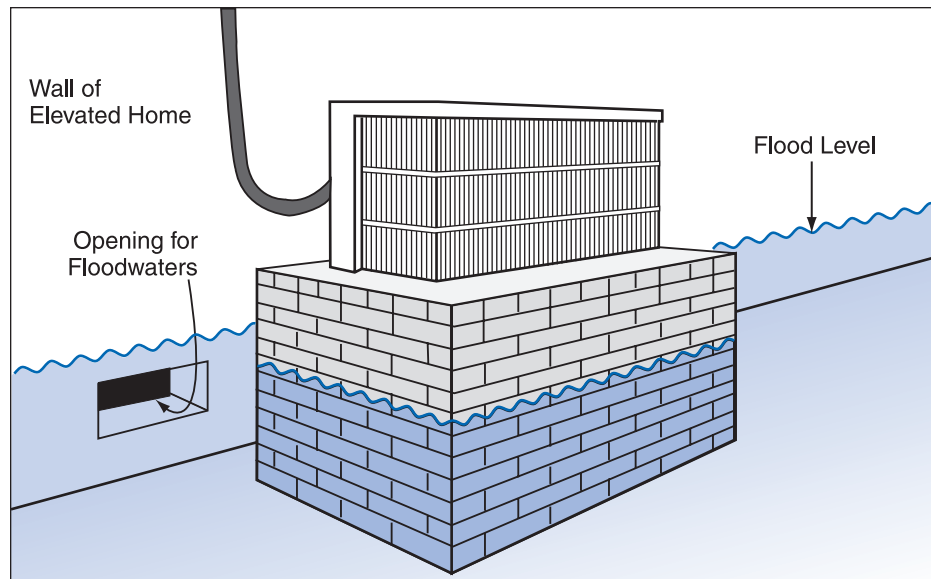

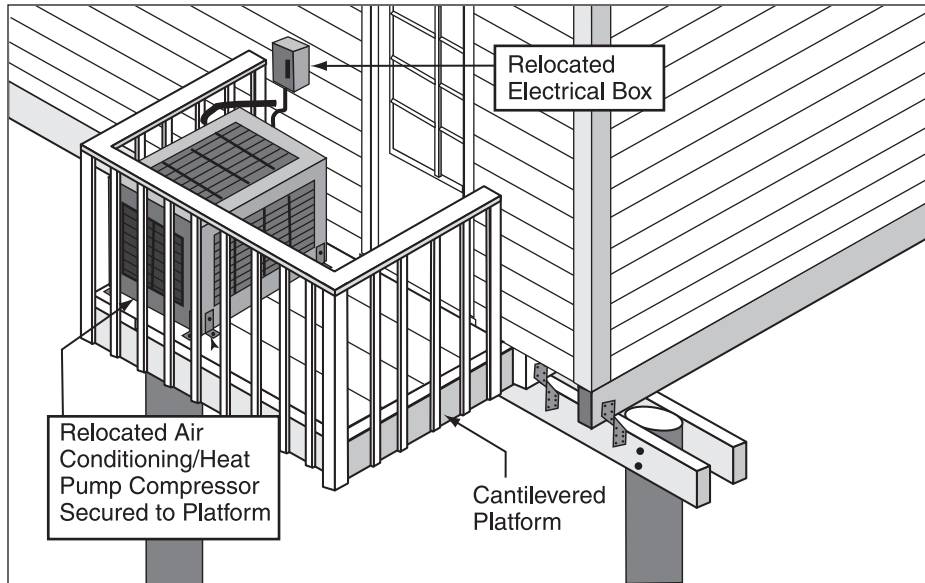

Figure 8-2. Air conditioning/heat pump compressor mounted on a cantilevered platform attached to a home elevated on an open foundation.

When you elevate service equipment, you should always consider raising it at least 1 foot above the BFE, just as you should when you protect your home with one of the methods described in this guide. Elevating service equipment an additional 1 or 2 feet often will not increase your retrofitting costs significantly. Note that some utility companies may not allow you to elevate electric or gas meters.



NOTE

When elevating HVAC and other equipment, be sure to leave sufficient space around the unit to allow access for maintenance work.

The feasibility of elevating equipment inside a basement or garage will depend largely on the flood level. If the flood level is only 1 to 2 feet above the floor, large pieces of equipment such as furnaces, hot water heaters, and appliances can be elevated on platforms constructed of concrete or masonry block. As the height of the flood level above the floor increases, the amount of space available above the flood level diminishes and elevation will be feasible only for smaller pieces of equipment (e.g., electrical system components, ventilation ductwork, or specialized equipment such as furnaces designed to be suspended from the ceiling). If the flood level is at or near the ceiling, elevation in lower areas will not be possible. Instead, equipment will have to be relocated or protected in place as described in Section 8.2.2.

Keep in mind that most service equipment must remain accessible for routine maintenance. For example, your fuel company must be able to reach your fuel tank to fill or empty it. Before elevating any service equipment, your contractor should check with the utility company to find out whether it has any requirements that would prohibit elevation or restrict elevation height.

Also, remember that any large equipment elevated on platforms or pedestals, both inside and outside your home, may be more vulnerable to wind and earthquake damage. Before these

elevation methods are used, a design professional must determine the expected wind and earthquake forces at the site and account for them by anchoring.

This precaution is especially important for elevated fuel storage tanks, which could rupture if they were dislodged or toppled by wind and earthquake forces. In earthquake-prone areas, fuel storage tanks are sometimes equipped with cutoff valves that can help prevent leaks when supply lines are ruptured. Your utility service provider can give you more information about cutoff valves and other ways to protect fuel storage tanks from natural hazards.

8.2.2 Relocation

When space permits, you can move service equipment from a basement or other area below the flood level to an upper floor of the home or even an attic. Relocation will usually require more extensive changes to both your home and the equipment being moved, but it often provides a greater level of flood protection because the relocated equipment will be farther above the flood level. In some situations, you may also be able to relocate outside equipment to higher ground, but only when the slope of your lot and other site conditions permit.



NOTE

Chapters 3 and 4 of FEMA 348, *Protecting Building Utilities from Flood Damage*, discuss relocation of utility equipment in detail.

Another relocation option is to build a new, elevated utility room as an addition to your home. The addition could be built on an open foundation or extended foundation walls.

8.2.3 Protection in Place

When elevation and relocation are infeasible or impractical, you may be able to protect service equipment in place with low floodwalls and shields and with anchors and tiedowns that prevent flotation. Plumbing systems can be protected with valves that prevent wastewater from backing up into the home.

Floodwalls and Shields

Floodwalls and shields are normally components of dry floodproofing systems (Chapter 7) that are used to protect entire buildings. However, if a building is wet floodproofed, they can be used for the protection of small areas within a building that contain service equipment that is not elevated or relocated. For example, you can build a concrete floodwall that surrounds one or more pieces of service equipment, such as a furnace and water heater (Figure 8-3).

If the expected depth of flooding is less than about 12 inches, the floodwall would be low enough that you could step over it to reach the protected equipment. A higher floodwall can include an opening equipped with a removable shield, as shown in Figure 8-3. The opening permits easy access to the protected equipment. In this example, the shield does not interfere with

the normal operation of the equipment, so it should be left in place and removed only when necessary to service the equipment. Leaving the shield in place allows the barrier to function without human intervention.

In general, barriers and shields of the type shown in Figure 8-3 are practical only when flood depths are less than about 3 feet. The greater hydrostatic pressure exerted by deeper water requires barriers and shields that are more substantial, have more complex designs, and are, therefore, more expensive. As discussed in Chapter 7, all floodwalls should provide at least 1 foot of freeboard above the expected flood elevation.

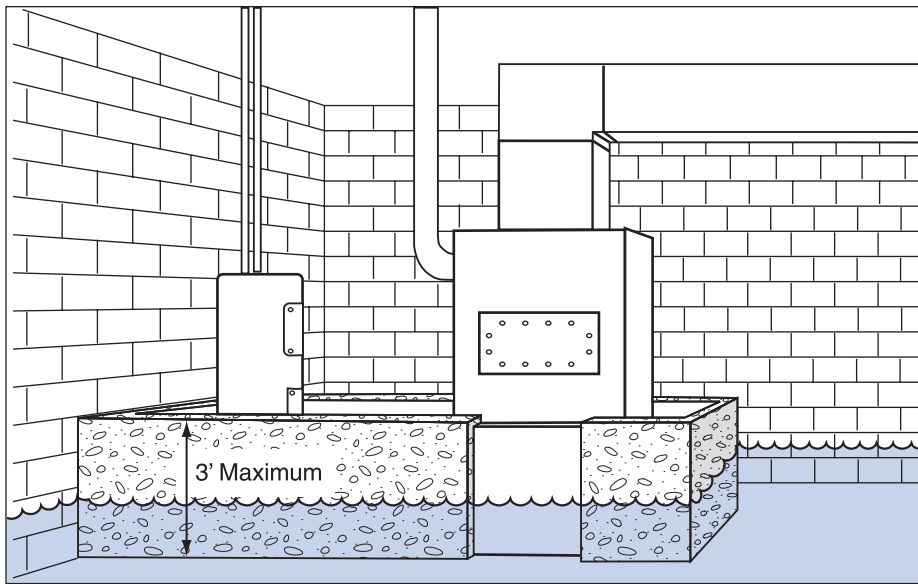

Figure 8-3. Water heater and furnace protected by a concrete floodwall with opening and gasketed shield.

Regardless of the height of the barrier, the area it protects should be equipped with a sump pump that will remove any water that accumulates through seepage.

8.2.4 Anchors and Tiedowns

Anchors and tiedowns are used primarily for aboveground storage tanks (ASTs) that are not elevated above the flood level and for underground storage tanks (USTs). Both types are extremely vulnerable to flotation. Floodwaters and debris impact forces act directly on ASTs and USTs can be forced out of the ground by the buoyancy force of saturated soils. When either type of tank is displaced, its connections can be severed and the escaping fuel can cause hazardous conditions.

ASTs can be anchored with metal straps or cables that cross over the tank and connect to ground anchors. The length and type of ground anchor



NOTE

For more information about anchoring fuel storage tanks, refer to FEMA 348, *Protecting Building Utilities from Flood Damage* and the FEMA Fact Sheet series *Protect Your Property from Flooding, Anchor Fuel Tanks*.

you need will depend largely on the type of soil at the site. A design professional can advise you about anchors. Another way to anchor an AST is to embed its legs in a concrete slab (Figure 8-4).

Ground anchors can also be used for below-ground tanks. This method involves excavating the soil above the tank, placing steel I-beams across it, and connecting them to ground anchors. Again, check with a design professional concerning the required size and type of anchor. USTs can also be anchored with a concrete slab similar to the one shown in Figure 8-4. Installing the slab involves excavating around the tank and removing it temporarily while the slab is poured.

Another alternative is to excavate down to the tank and pour a concrete slab on top, making sure not to cover access openings.

On all tanks below the flood level, both aboveground and underground, flexible connections must be used between the tank and the supply line. Also, the vent and filler tubes must extend above the DFE (Figure 8-4). If you have adequate warning of an impending flood, top off the tank. A full tank will be less susceptible to corrosion from accumulated moisture and will be heavier and better able to resist buoyancy.



WARNING

Be especially careful when anchoring storage tanks or other service equipment in floodways, V zones, and other high-risk areas. You must consider the effects of high flow velocities, wave action, fast moving floodborne debris, and extensive erosion and scour wherever these hazards are likely to occur.

Figure 8-4. Anchoring a fuel storage tank with a concrete slab.

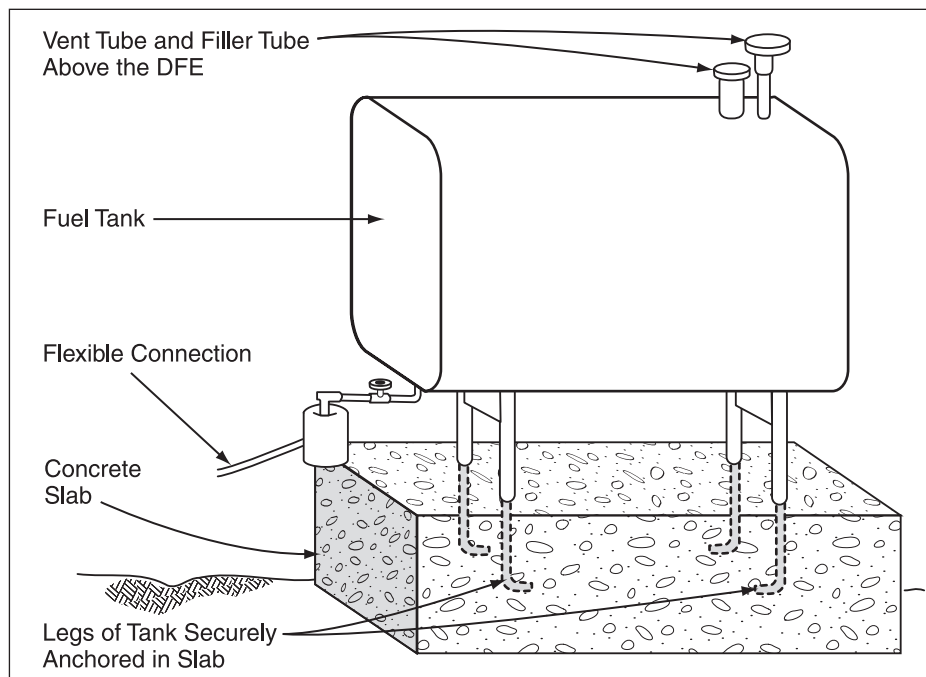

Although anchoring is particularly important for storage tanks, remember that the levels of future floods can rise higher than expected and inundate service equipment that you have elevated, relocated, or protected in place. For this reason, service equipment should be anchored whenever possible so that it will remain in place when acted on by flood forces.

8.2.5 Backflow Valves

Flooding can inundate and overload sanitary sewer systems and combined sanitary/storm sewer systems. As a result, water can flow backward through sewer lines and out through toilets or drains. The best solution to this problem is usually to install a backflow valve. These valves include check valves, gate valves, and dual backflow valves.

Check valves operate without human intervention. Under normal conditions, they allow wastewater to flow from the home to the main sewer line. When flooding causes the flow to reverse, a flap or other check mechanism in the valve prevents water from flowing back into the home. A disadvantage of check valves is that they can become blocked open by debris and fail to operate. For this reason, check valves must be inspected regularly and cleaned as necessary.

Gate valves are manually operated, provide a better seal, and are unlikely to be blocked open. However, they are more expensive than check valves and require human intervention.

The third alternative is dual backflow valves, which combine the benefits of the check valve and the gate valve. As the most expensive of the three types, the dual backflow valve should be considered primarily for use in homes subject to repeated backflow flooding. Gate valves and dual backflow valves are usually installed outside the home in a valve pit (Figure 8-5).



NOTE

The installation of backflow valves and other plumbing modifications is usually regulated by State and local building codes. A plumber or contractor licensed to work in your area will know about the code requirements that apply to your retrofitting project.

Figure 8-5. Dual backflow valve installed in an exterior valve pit.

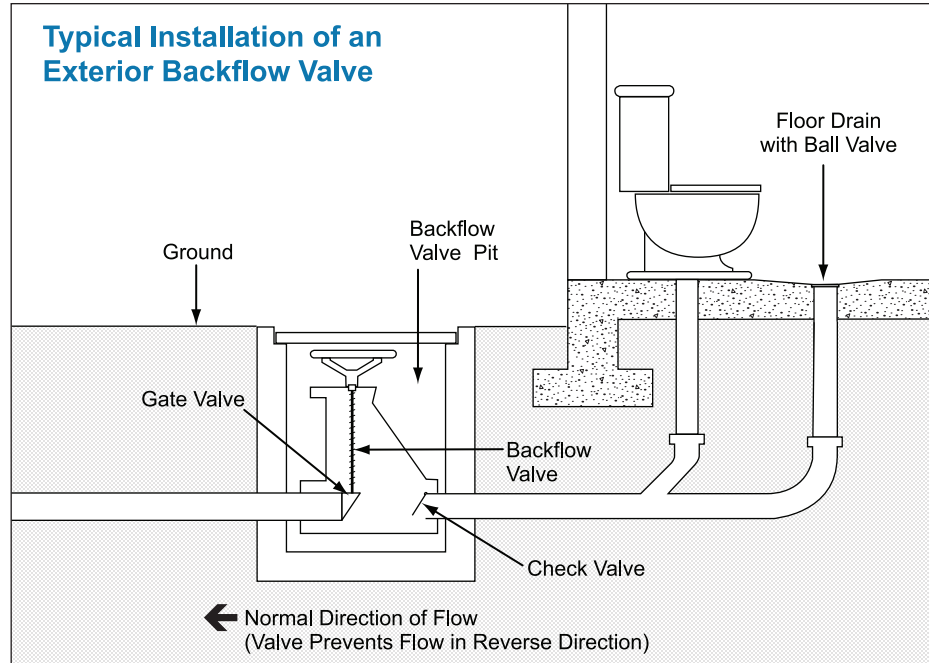

Appendix A

Bibliography and Sources of Information

FEMA and other organizations have produced many documents about floodproofing and flood hazard mitigation. Those listed below provide information that may be useful to a homeowner who is thinking about undertaking a retrofitting project or to a homeowner's designer or builder.

American Society of Civil Engineers, *Minimum Design Loads for Buildings and Other Structures*, ASCE 7-05, 2006, <http://pubs.asce.org/books/standards>.

American Society of Civil Engineers, *Flood Resistant Design and Construction*, ASCE 24-05, 2006, <http://pubs.asce.org/books/standards>.

Federal Emergency Management Agency

Recommended Residential Construction for Coastal Areas: Building on Strong and Safe Foundations, FEMA 550, December 2009, <http://www.fema.gov/library/viewRecord.do?id=1853>.

Protecting Manufactured Homes from Floods and Other Hazards, FEMA P-85, November 2009, <http://www.fema.gov/library/viewRecord.do?id=1577>.

Flood Insurance Manual, 1 October 2009, <http://www.fema.gov/business/nfip/manual200910.shtm>.

Protect Your Property from Flooding, Anchor Fuel Tanks, April 2008, <http://www.fema.gov/library/viewRecord.do?id=3262>.

Reducing Flood Losses Through the International Codes, Third Edition, 2008, <http://www.fema.gov/library/viewRecord.do?id=2094>.

Mitigation Assessment Team Report – *Hurricane Katrina in the Gulf Coast*, FEMA 549, July 2006, <http://www.fema.gov/library/viewRecord.do?id=1857>.

Guide to Flood Maps, FEMA 258, March 2006, <http://www.fema.gov/library/viewRecord.do?id=1644>.

Home Builder's Guide to Coastal Construction: Technical Fact Sheet Series, FEMA 499, August 2005, <http://www.fema.gov/library/viewRecord.do?id=1570>.

Mitigation Assessment Team Report – *Hurricane Ivan in Alabama and Florida*, FEMA 489, August 2005, <http://www.fema.gov/library/viewRecord.do?id=1569>.

Mitigation Assessment Team Report – *Hurricane Charley in Florida*, FEMA 488, April 2005, <http://www.fema.gov/library/viewRecord.do?id=1444>.

Engineering Principles and Practices for Retrofitting Flood-Prone Residential Structures, FEMA 259, Second Edition, June 2001, <http://www.fema.gov/library/viewRecord.do?id=1645>.

Coastal Construction Manual, Third Edition, FEMA 55, June 2000, <http://www.fema.gov/library/viewRecord.do?id=1671>.

Above the Flood: Elevating Your Floodprone House, FEMA 347, May 2000, <http://www.fema.gov/library/viewRecord.do?id=1424>.

Protecting Building Utilities from Flood Damage, FEMA 348, November 1999, <http://www.fema.gov/library/viewRecord.do?id=1750>.

Mitigation of Flood and Erosion Damage to Residential Buildings in Coastal Areas, FEMA 257, October 1994, <http://www.fema.gov/library/viewRecord.do?id=1643>.

Answers to Questions About Substantially Damaged Buildings, FEMA 213, May 1991, <http://www.fema.gov/library/viewRecord.do?id=1636>.

Federal Emergency Management Agency National Flood Insurance Program Technical Bulletins

Openings in Foundation Walls and Walls of Enclosures, Technical Bulletin 1, August 2008, <http://www.fema.gov/library/viewRecord.do?id=1579>.

Flood Damage-Resistant Materials Requirements, Technical Bulletin 2, August 2008, <http://www.fema.gov/library/viewRecord.do?id=1580>.

Free-of-Obstruction Requirements, Technical Bulletin 5, August 2008, <http://www.fema.gov/library/viewRecord.do?id=1718>.

Design and Construction Guidance for Breakaway Walls Below Elevated Coastal Buildings, Technical Bulletin 9, August 2008, <http://www.fema.gov/library/viewRecord.do?id=1722>.

Crawlspace Construction for Buildings Located in Special Flood Hazard Areas, FIA-TB-11, November 2001, <http://www.fema.gov/library/viewRecord.do?id=1724>.

Ensuring That Structures Built on Fill In or Near Special Flood Hazard Areas are Reasonably Safe from Flooding, FIA-TB-10, May 2001, <http://www.fema.gov/library/viewRecord.do?id=1723>.

Corrosion Protection for Metal Connectors in Coastal Areas, FIA-TB-8, August 1996, <http://www.fema.gov/library/viewRecord.do?id=1721>.

Wet Floodproofing Requirements, FIA-TB-7, December 1993, <http://www.fema.gov/library/viewRecord.do?id=1720>.

Federal Emergency Management Agency and the American Red Cross, *Repairing Your Flooded Home*, FEMA 234 and ARC 4477, August 1992, <http://www.fema.gov/library/viewRecord.do?id=1418>.

Federal Emergency Management Agency and the National Association of Home Builders (NAHB), *Best Build 3: Protecting a Flood-Prone Home* (30-minute video). 9-0048, 1998.

Florida Department of Community Affairs, Division of Emergency Management, Bureau of Recovery and Mitigation, State Assistance Office for the NFIP, *Retrofitting and Flood Mitigation in Florida*, January 2002, <http://www.floridadisaster.org/brm/Forms/Retrofitting%20and%20Flood%20Mitigation%20booklet.pdf>.

International Code Council (ICC), *2009 International Building Code*[®], IBC[®] 2009, 2009, http://www2.iccsafe.org/states/2009ICodes/Building/Building_Frameset.html.

International Code Council, *2009 International Existing Building Code*[®], IEBC[®] 2009, 2009, <http://www.iccsafe.org/Store/Pages/Product.aspx?id=3550x09>.

International Code Council, *2009 International Residential Code*[®] for One- and Two-Family Residential Dwellings, IRC[®] 2009, 2009, <http://www.iccsafe.org/Store/Pages/Product.aspx?id=3100X09>.

National Fire Protection Association, *NFPA 5000: Building Construction and Safety Code*, 2009 Edition, <http://www.nfpa.org/catalog>.

U.S. Army Corps of Engineers

Nonstructural Flood Damage Reduction within the Corps of Engineers, October 2001, <http://www.usace.army.mil/Library/Pages/default.aspx>.

Flood Proofing Performance—Successes and Failures, December 1998, <http://www.usace.army.mil/Library/Pages/default.aspx>.

Flood Proofing—Techniques, Programs, and References, January 1996, <http://www.usace.army.mil/Library/Pages/default.aspx>.

Flood-Proofing Regulations, EP 1165-2-314, December 15, 1995, <http://www.usace.army.mil/Library/Pages/default.aspx>.

Local Flood Proofing Programs, June 1994, <http://www.usace.army.mil/Library/Pages/default.aspx>.

Flood Proofing – How to Evaluate Your Options, July 1993, <http://www.usace.army.mil/Library/Pages/default.aspx>.

A Flood Proofing Success Story Along Dry Creek at Goodlettsville, Tennessee, April 1993, <http://www.usace.army.mil/Library/Pages/default.aspx>.

Flood Proofing Techniques, Programs, and References, February 1991, <http://www.usace.army.mil/Library/Pages/default.aspx>.

Raising and Moving a Slab-on-Grade House, 1990, <http://www.usace.army.mil/Library/Pages/default.aspx>.

For additional information about natural hazards and hazard mitigation, visit the Internet sites listed below:

American Red Cross (ARC) <http://www.redcross.org>

Applied Technology Council (ATC) <http://www.atcouncil.org>

Association of State Floodplain Managers (ASFPM) <http://www.floods.org>

Disaster Research Center (DRC), University of Delaware <http://www.udel.edu/DRC/>

Federal Alliance for Safe Homes (FLASH) <http://www.flash.org/>

Federal Emergency Management Agency (FEMA) <http://www.fema.gov>

Hazard Reduction and Recovery Center (HRRC), Texas A&M <http://archone.tamu.edu/hrrc/>

Institute for Business & Home Safety (IBHS) <http://www.disastersafety.org/>

National Association of Home Builders (NAHB) <http://www.nahb.org/>

National Flood Insurance Program (NFIP) <http://www.floodsmart.gov/floodsmart/>

National Geophysical Data Center (NGDC) <http://www.ngdc.noaa.gov>

Natural Hazards Center at the University of Colorado, Boulder, Colorado <http://www.colorado.edu/hazards>

National Information Service for Earthquake Engineering (NISEE), University of California at Berkeley <http://nisee.berkeley.edu>

Storm Struck – A Tale of Two Homes <http://www.stormstruck.com/>

U. S. Army Corps of Engineers (USACE) – National Nonstructural/Floodproofing Committee (NFPC) <https://www.nwo.usace.army.mil/nfpc/>

U.S. Department of Housing and Urban Development (HUD) – Office of Policy Development and Research (PDNR) <http://www.huduser.org/portal/publications/pdrpubli.html>

U. S. Geological Survey (USGS) – Earthquake Hazards Program <http://quake.wr.usgs.gov>

U. S. Natural Resources Conservation Service (NRCS) <http://www.nrcs.usda.gov>

Wind Engineering Research Center (WERC), Texas Tech University (TTU) <http://www.depts.ttu.edu/weweb/>

Appendix B

Acronyms

A

AIA	American Institute of Architects
ARC	American Red Cross
ASCE	American Society of Civil Engineers
ASFPM	Association of State Floodplain Managers
AST	aboveground storage tank
ATC	Applied Technology Council

B

BFE	base flood elevation
-----	----------------------

C

CDC	Centers for Disease Control
CFR	Code of Federal Regulations
CMU	concrete masonry unit
CRS	Community Rating System

D

DFE	design flood elevation
DFIRM	Digital FIRM
DHS	U.S. Department of Homeland Security
DRC	Disaster Recovery Center

DRC Disaster Research Center (University of Delaware)

F

FEMA Federal Emergency Management Agency

FIA Federal Insurance Administration

FIRM Flood Insurance Rate Map

FIS Flood Insurance Study

FLASH Federal Alliance for Safe Homes

FMA Flood Mitigation Assistance

fps feet per second

H

HMA Hazard Mitigation Assistance

HMGP Hazard Mitigation Grant Program

HRRC Hazard Reduction and Recovery Center (Texas A&M)

HUD U.S. Housing and Urban Development

HVAC heating, ventilation, and air conditioning

I

IASM International Association of Structural Movers

IBC® International Building Code®

IBHS Institute for Business and Home Safety

ICC Increased Cost of Compliance

ICC International Code Council

IEBC® International Existing Building Code®

IRC® International Residential Code®

L

LAG	lowest adjacent grade
LIMWA	Limit of Moderate Wave Action
LOMA	Letter of Map Amendment

M

mph	miles per hour
MSC	Map Service Center
msl	mean sea level

N

NAHB	National Association of Home Builders
NAVD	North American Vertical Datum
NFIA	National Flood Insurance Act
NFIF	National Flood Insurance Fund
NFIP	National Flood Insurance Program
NFPA	National Fire Protection Association
NFPC	Nonstructural Flood Proofing Committee (USACE)
NGDC	National Geophysical Data Center
NGVD	National Geodetic Vertical Datum
NISEE	National Information Service for Earthquake Engineering
NOAA	National Oceanic and Atmospheric Administration
NRCS	National Resources Conservation Service

O

OSB	oriented-strand board
-----	-----------------------

P

PDM	Pre-Disaster Mitigation
PVC	polyvinyl chloride
RFC	Repetitive Flood Claims

S

SBA	Small Business Administration
SEI	Structural Engineering Institute
SFHA	Special Flood Hazard Area
SFIP	Standard Flood Insurance Policy
SRL	Severe Repetitive Loss

T

TB	Technical Bulletin
TTU	Texas Tech University

U

USACE	U. S. Army Corps of Engineers
U.S.C.	United States Code
USDA	U.S. Department of Agriculture
USGS	U.S. Geological Survey
UST	underground storage tank

W

WERC	Wind Engineering Research Center (Texas Tech)
------	---

Glossary

Many of the terms defined here are also defined in the margins of pages on which they first appear or explained in the body of the text.

A

Acquisition – The process by which your State or local government purchases your flood-prone property, demolishes the building, and maintains the land as an open space.

Active retrofitting method – Method that will not function as intended without human intervention. See “passive retrofitting method.”

Adjacent grade – See “lowest adjacent grade (LAG).”

Alluvial fan flooding – Flooding that occurs on the surface of an alluvial fan (or similar landform) that originates at the apex of the fan and is characterized by high-velocity flows; active processes of erosion, sediment transport, and deposition; and unpredictable flow paths.

Armor – To protect fill slopes, such as the sides of a levee, by covering them with erosion-resistant materials such as rock or concrete.

B

Backfill – To fill in a hole with the soil removed from it or with other material, such as soil, gravel, or stone.

Backflow valve – See “check valve.”

Base flood – Flood that has a 1-percent probability of being equaled or exceeded in any given year (formerly known as the 100-year flood).

Base flood elevation (BFE) – Elevation of the 1-percent annual chance flood. This elevation is the basis of the insurance and floodplain management requirements of the National Flood Insurance Program.

Basement – As defined by the NFIP regulations, any area of a building having its floor subgrade (below ground level) on all sides.

Building envelope – The entire exterior surface of a building (including walls, doors, and windows) that encloses or envelopes the space within.

Buoyancy – The upward hydrostatic force that floodwater exerts on the floors of homes with enclosed spaces below the flood level.

C

Cast-in-place concrete – Concrete poured into forms at the construction site.

Check valve – Valve that allows water to flow in one direction, but automatically closes when the direction of flow is reversed.

Closure – Shield made of strong material, such as metal or wood, used to temporarily close openings in levees, floodwalls, and dry floodproofed buildings.

Coastal High Hazard Area – Area of special flood hazard (designated Zone V, VE, or V1 - V30 on a FIRM) that extends from offshore to the inland limit of a primary coastal dune along an open coast, and any other area subject to high-velocity wave action from storms or seismic sources.

Compaction – In construction, the process by which the density of earth fill is increased so that it will provide a sound base for a building or other structure.

Crawlspace – Type of foundation in which the lowest floor of a home is suspended above the ground on continuous foundation walls.

Cribbing – Cribbing usually consists of a framework of criss-crossed timbers that provides temporary structural support.

D

Debris – Materials carried by floodwaters, including objects of various sizes and suspended soils.

Design capacity – Volume of water that a channel, pipe, or other drainage line is designed to convey.

Design flood elevation (DFE) – Elevation of the highest flood, including freeboard, that a retrofitting method is intended to protect against.

Dry floodproofing – Protecting a building by sealing its exterior walls to prevent the entry of floodwaters.

Duration – How long a flood lasts. Can also refer to how long it takes for a creek, river, bay, or ocean to return to its normal level.

E

Elevation – In retrofitting, the process of raising a home or other building so that it is above the height of a given flood.

Elevation datum – Arbitrary surface that serves as a common reference for the elevations of points above or below it. Elevations are expressed in terms of feet, meters, or other units of measure and are identified as negative or positive, depending on whether they are above or below the datum. Three common datums are mean sea level (msl), NGVD, and NAVD.

Erosion – A general lowering of the ground surface over a wide area.

F

Federal Emergency Management Agency (FEMA) – Agency within DHS that administers the National Flood Insurance Program. The NFIP is the Federal program, created by Congress in 1968, that makes flood insurance available in communities that adopt and enforce floodplain management ordinances or laws that meet the minimum requirements of the NFIP regulations.

Federal Insurance Administration (FIA) – Component of FEMA directly responsible for administering the flood insurance aspects of the NFIP.

Fill – Material such as soil, gravel, or stone that is dumped in an area to increase the ground elevation. Fill is usually placed in layers and each layer is compacted (see “Compaction”).

Flap valve – See “check valve.”

Flash flood – A flood that rises and falls very quickly, usually characterized by high flow velocities. Flash floods often result from intense rainfall over a small area, usually in areas of steep terrain.

Flood – Under the NFIP, “a general and temporary condition of partial or complete inundation of normally dry land areas” from 1) the overland flow of a lake, river, stream, ditch, etc.; 2) the unusual and rapid accumulation or runoff of surface waters; and 3) mudflows or the sudden collapse of shoreline land.

Flood depth – Height of floodwaters above the surface of the ground at a given point.

Flood duration – Amount of time between the initial rise of floodwaters, including freeboard, and recession.

Flood elevation – Height of floodwaters above an elevation datum plane.

Flood frequency – Probability, expressed as a percentage, that a flood of a given size will be equaled or exceeded in any given year. The flood that has a 1-percent chance (1 in 100) of being equaled or exceeded in any given year (also known as the 100-year flood); similarly, the floods that have a 2-percent chance (1 in 50) and a 0.2-percent (1 in 500) of being equaled or exceeded in any year were formerly known as the 50-year and the 500-year floods, respectively).

Floodplain – Any area susceptible to inundation by water from any source. See “regulatory floodplain.”

Floodplain management – Program of corrective and preventive measures for reducing flood damage, including flood control projects, floodplain land use regulations, floodproofing or retrofitting of buildings, and emergency preparedness plans.

Floodproofing – Structural or nonstructural changes or adjustments included in the design, construction, or alteration of a building that reduce damage to the building and its contents from flooding and erosion. See “Dry floodproofing” and “Wet floodproofing.”

Floodwall – Flood barrier constructed of manmade materials, such as concrete or masonry.

Floodway – Portion of the SHFA that must be kept free of new development so that flood elevations will not increase. The floodway usually consists of the stream channel and land along either side. The flood hazard is usually greater in the floodway than in the surrounding areas of the SFHA, referred to as the “flood fringe.”

Flow velocity – Speed at which water moves during a flood. Velocities usually vary across the floodplain. They are usually greatest near the channel and lowest near the edges of the floodplain.

Footing – The base of a foundation, usually made of concrete and may be reinforced with steel bars. Foundation walls are supported on continuous footings; separate foundation members, such as piers, are supported on individual footings.

Footprint – The land area a home covers. This area is equal to the length of the home multiplied by its width. The footprint is not necessarily equal to the total square footage of the home.

Freeboard – Additional amount of height included in the DFE to provide a factor of safety.

Frequency – See “flood frequency.”

G

Grade beam – In a slab foundation, a support member cast as an integral part of the slab, as opposed to a separate footing.

H

Hazard mitigation – Sustained action taken to reduce or eliminate long-term risk to people and property from hazards such as floods, winds, earthquakes, and fires.

Human intervention – Any action that a person must take to enable a flood protection measure to function as intended. This action must be taken every time flooding threatens.

Hydrodynamic force – Force exerted by moving water.

Hydrostatic force – Force exerted by water at rest, including lateral pressure on walls and uplift (buoyancy) on floors.

I

Impervious soils – Soils that resist penetration by water.

Intensity of rainfall – The amount of rain that falls during a given amount of time. It is usually expressed in inches of rainfall per hour. The higher the number of inches per hour, the greater the intensity.

J

Jetting – A process in which the hole for the installation of a pile is made by a high-pressure stream of water from a nozzle attached to the bottom of the pile.

L

Letter of Map Amendment (LOMA) – Occasionally, a small area is inadvertently shown to be within the SFHA on a FIRM, even though the ground is at or above the BFE. If this occurs, an individual property owner may submit survey information to FEMA and request that FEMA issue a document that officially removes a property from the SFHA, called a Letter of Map Amendment.

Levee – Flood barrier constructed of compacted soil.

Local officials – Community employees who are responsible for floodplain management, zoning, permitting, building code enforcement, and building inspection.

Lowest adjacent grade (LAG) – The lowest ground surface that touches any of the exterior walls of a home.

Lowest floor – Floor of the lowest enclosed area within the building, including the basement. The only exception is an enclosed area below an elevated building, but only when the enclosed area is used solely for parking, building access, or storage and is compliant with relevant regulations. The elevation of the lowest floor can be very important in retrofitting.

M

Masonry veneer – Nonstructural, decorative, exterior layer of brick, stone, or concrete block added to the walls of a building.

Mean sea level (msl) – Datum plane; the average height of the sea for all stages of the tide, usually determined from hourly height observations over a 19-year period on an open coast or in adjacent waters having free access to the sea.

Mitigation reconstruction – The construction of an improved, elevated building on the same site where an existing building and/or foundation has been demolished. Mitigation reconstruction is only permitted if traditional structure elevation cannot be implemented.

N

National Geodetic Vertical Datum (NGVD) – Elevation datum plane previously used by FEMA for the determination of flood elevations.

North American Vertical Datum (NAVD) – Elevation datum currently used by FEMA for the determination of flood elevations.

P

Passive retrofitting method – Method that operates automatically, without human intervention. See “active retrofitting method.”

Permeable soils – Soils that water can easily penetrate and flow through.

Pier – Vertical support member of masonry or cast-in-place concrete that is designed and constructed to function as an independent structural element in supporting and transmitting both building loads and environmental loads to the ground.

Piling – Vertical support member of wood, steel, or precast concrete that is driven or jetted into the ground and supported primarily by friction between the pilings and the surrounding earth. Pilings often cannot act as independent support units and therefore are often braced with connections to other pilings.

Post – Long vertical support member of wood or steel set in holes that are backfilled with compacted material. Posts often cannot act as independent support units and therefore are often braced with connections to other posts.

Precast concrete – Concrete materials such as posts, beams, and blocks that are brought to the construction site in finished form.

R

Rates of rise and fall – How rapidly the elevation of the water rises and falls during a flood.

Regulatory floodplain – Flood hazard area within which a community regulates development, including new construction, the repair of substantially damaged buildings, and substantial improvements to existing buildings. In communities participating in the NFIP, the regulatory floodplain must include at least the area inundated by the base flood, also referred to as the Special Flood Hazard Area (SFHA).

Reinforcement – Inclusion of steel bars in concrete members and structures to increase their strength.

Relocation – In retrofitting, the process of moving a home or other building to a new location outside the flood hazard area.

Retrofitting – Making changes to an existing home or other building to protect it from flooding or other hazards.

Riprap – Pieces of rock or crushed stone added to the surface of a fill slope, such as the side of a levee, to prevent erosion.

S

Saturated soils – Soils that have absorbed, to the maximum extent possible, water from rainfall or snowmelt.

Scour – A localized loss of soil, often around a foundation element.

Sealant – In retrofitting, a waterproofing material or substance used to prevent the infiltration of floodwater.

Service equipment – The utility systems, heating and cooling systems, and large appliances in a retrofitted home.

Slab-on-grade – Type of foundation in which the lowest floor of the home is formed by a concrete slab that sits directly on the ground. The slab may be supported by independent footings or integral grade beams.

Special Flood Hazard Area (SFHA) – An area delineated on a FIRM as being subject to inundation by the base flood, designated Zone A, AE, A1 - A30, AR, AO, AH, A99, V, VE, or V1 - V30.

Storm surge – The rise in the level of the ocean that results from the decrease in atmospheric pressure associated with hurricanes and other storms.

Subgrade – Below the level of the ground surface.

Substantial damage – Damage to a building, regardless of the cause, is considered substantial damage if the cost of restoring the building to its before-damage condition would equal or exceed 50 percent of the structure before the damage occurred. Consult your local officials about determining the value of your home.

Substantial improvement – An improvement of a building (such as reconstruction, rehabilitation, or an addition) is considered a substantial improvement if its cost equals or exceeds 50 percent of the market value of the building before the start of construction of the improvement.

Sump pump – Device used to remove water from seepage or rainfall that collects in areas protected by a levee, floodwall, or dry floodproofing. In addition, a sump pump is often part of a standard home drainage system that removes water that collects below a basement slab floor.

T

Tsunami – Great sea wave produced by an undersea earth movement or volcanic eruption.

U

Underseepage – Water that migrates downward along the sealed walls of a home and then under the foundation.

V

Veneer – See “masonry veneer.”

W

Walkout-on-grade basement – Basement whose floor is at ground level on at least one side of a home. The term “walkout” is used because most basements of this type have an outside door or doors (entry door, garage door, or both) at ground level. A walkout-on-grade basement is not considered a basement under the NFIP. See “basement.”

Watershed – The geographic area that contributes surface water, from rain or melting snow, to a stream.

Wave action – The characteristics and effects of waves that move inland from an ocean, bay, or other large body of water. Large, fast-moving waves can cause extreme erosion and scour, and their impact on buildings can cause severe damage. During hurricanes and other high-wind events, storm surge and wind increase the destructiveness of waves and cause them to reach higher elevations and penetrate farther inland.

Wet floodproofing – Protecting a building by allowing floodwaters to enter so that internal and external hydrostatic pressures are equalized. Usually, only enclosed areas used for parking, building access, or storage are wet floodproofed.

Appendix C

FEMA Offices

The addresses and telephone numbers of FEMA Headquarters and the 10 FEMA Regional Offices are listed below. Staff members of the Regional Office for your area can give you more information about retrofitting, hazard mitigation, and the National Flood Insurance Program.

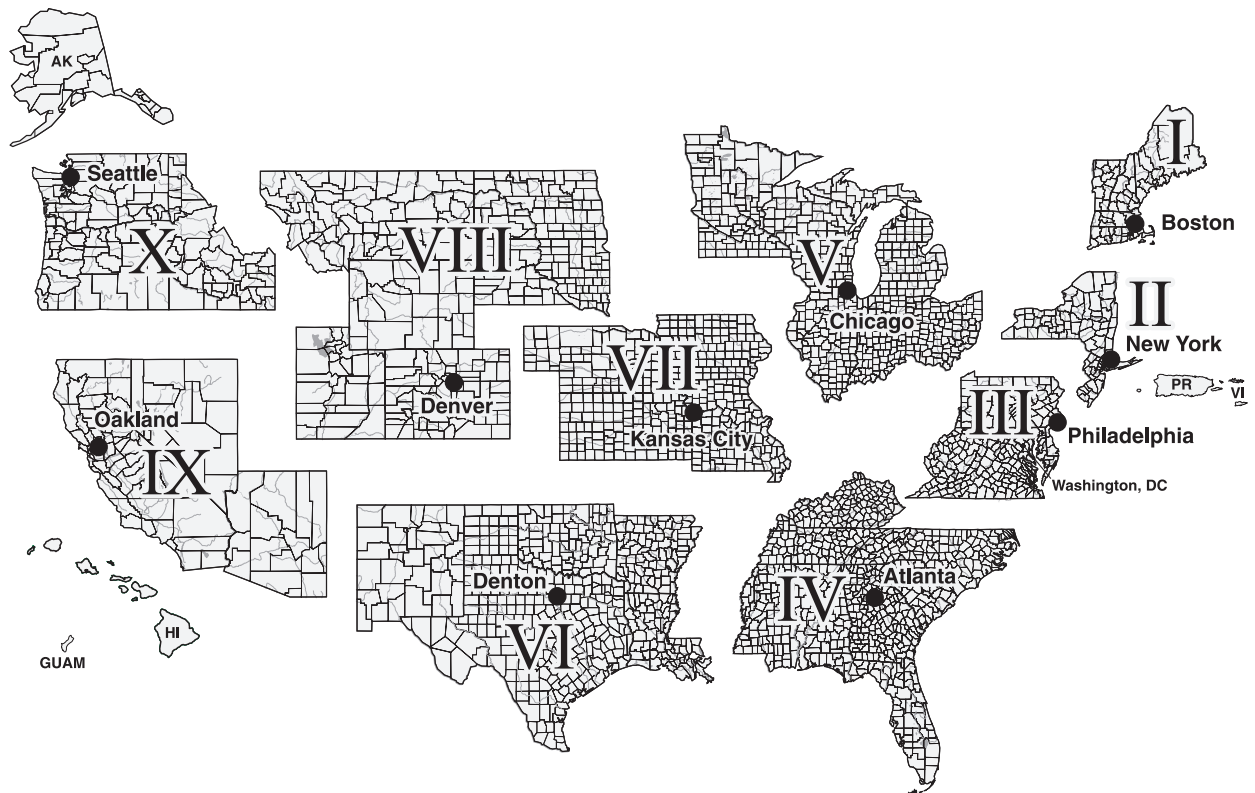

FEMA HEADQUARTERS

500 C Street, SW.
 Washington, DC 20472
 (202) 646-2500, (800) 621-FEMA (3362)
 TTY: (800) 462-7585

REGION I – CT, MA, ME, NH, RI, VT

99 High Street, Sixth Floor
 Boston, MA 02110
 (617) 956-7506

REGION II – NJ, NY, PR, VI

26 Federal Plaza, Suite 1337
New York, NY 10278-0002
(212) 680-3600

REGION III – DC, DE, MD, PA, VA, WV

615 Chestnut Street
One Independence Mall, Sixth Floor
Philadelphia, PA 19106-4404
(215) 931-5608

REGION IV – AL, FL, GA, KY, MS, NC, SC, TN

3003 Chamblee Tucker Road
Atlanta, GA 30341
(770) 220-5200

REGION V – IL, IN, MI, MN, OH, WI

536 South Clark Street, Sixth Floor
Chicago, IL 60605-1521
(312) 408-5500

REGION VI – AR, LA, NM, OK, TX

Federal Regional Center
800 North Loop 288
Denton, TX 76209-3698
(940) 898-5399

REGION VII – IA, KS, MO, NE

9221 Ward Parkway, Suite 300
Kansas City, MO 64114-3372
(816) 283-7063

REGION VIII – CO, MT, ND, SD, UT, WY

Denver Federal Center, Building 710
P.O. Box 25267
Denver, CO 80255-0267
(303) 235-4800

REGION IX – AZ, CA, HI, NV, American Samoa, Guam, Commonwealth of the Northern Mariana Islands, Republic of the Marshall Islands, Federated States of Micronesia

1111 Broadway, Suite 1200
Oakland, CA 94607-4052
(510) 627-7100

REGION X – AK, ID, OR, WA

Federal Regional Center
130 228th Street, SW.
Bothell, WA 98021-8627
(425) 487-4600

On October 1, 2009, as part of FEMA's Digital Vision initiative, FEMA discontinued general distribution of paper mapping products, including Flood Insurance Rate Maps (FIRMs) and Flood Insurance Study (FIS) reports. Electronic copies of FIRMs and FIS reports are available from the FEMA Map Service Center online at <http://msc.fema.gov>. For additional information, call the FEMA Map Service Center toll-free at 1-800-358-9616 or contact them by mail at the following address:

FEMA Map Service Center
PO Box 1038
Jessup, MD 20794-1038

Appendix D

NFIP State Coordinating Agencies

ALABAMA

Department of Economic and Community Affairs

Office of Water Resources

401 Adams Avenue, Suite 434

P.O. Box 5690

Montgomery, AL 36103-5690

Phone: (334) 353-0853, (877) 252-9283

Fax: (334) 242-0776

<http://www.adeca.alabama.gov/water/>

ALASKA

Alaska Department of Community and Economic Development

550 West 7th Avenue, Suite 1770

Anchorage, AK 99501-3510

Phone: (907) 269-4500

<http://www.commerce.state.ak.us/>

ARIZONA

Arizona Department of Water Resources

3550 North Central Avenue

Phoenix, AZ 85012-2105

Phone: (602) 771-8657

Fax: (602) 771-8691

<http://www.azwater.gov/>

ARKANSAS

Arkansas Natural Resources Commission

101 East Capitol, Suite 350

Little Rock, AR 72201-3823

Phone: (501) 682-3969

Fax: (501) 682-3991

<http://www.anrc.arkansas.gov/>

CALIFORNIA

California Department of Water Resources

2825 Watt Avenue, Suite 100

Sacramento, CA 95821

Phone: (916) 574-1475
Fax: (916) 574-1478
<http://www.water.ca.gov/>

COLORADO

Colorado Water Conservation Board

1313 Sherman Street, Room 721
Denver, CO 80203
Phone: (303) 866-3441
Fax: (303) 866-4474
<http://cwcb.state.co.us/>

CONNECTICUT

Department of Environmental Protection

79 Elm Street
Hartford, CT 06106
Phone: (860) 424-3537
Fax: (860) 424-4075
<http://www.ct.gov/dep/>

DELAWARE

Department of Natural Resources and Environmental Control

89 Kings Highway
Dover, DE 19901
Phone: (302) 739-9921
Fax: (302) 739-6724
<http://www.dnrec.delaware.gov/>

DISTRICT OF COLUMBIA

Department of the Environment

Watershed Protection Division
51 N Street, NE., Room 5021
Washington, DC 20002
Phone: (202) 535-2248
Fax: (202) 535-1364
http://app.doh.dc.gov/services/administration_offices/environmental/watershed/watershed_division.shtm

FLORIDA

Division of Emergency Management

2555 Shumard Oak Boulevard
Tallahassee, Florida 32399-2100
Phone: (850) 413-9816
<http://www.floridadisaster.org/>

GEORGIA

Department of Natural Resources

7 Martin Luther King, Jr., Drive, Suite 440
Atlanta, GA 30334
Phone: (404) 656-6382
Fax: (404) 656-6383
<http://www.gadnr.org/>

GUAM

Guam Department of Public Works

Post Office Box 2877
Agana, Guam 96910
Phone: (671) 646-3131
Fax: (671) 649-6178
<http://www.dpw.guam.gov>

HAWAII

Hawaii Department of Land and Natural Resources

1151 Punchbowl Street
P.O. Box 373
Honolulu, HI 96809
Phone: (808) 587-0267
Fax: (808) 587-0283
<http://hawaii.gov/dlnr/>

IDAHO

Department of Water Resources

322 East Front Street
Boise, ID 83720
Phone: (208) 287-4928
Fax: (208) 287-6700
<http://www.idwr.idaho.gov/>

ILLINOIS

Illinois Department of Natural Resources

Office of Water Resources
One Natural Resources Way
Springfield, IL 62702-1271
Phone: (217) 782-4428
Fax: (217) 785-5014
<http://dnr.state.il.us/OWR/>

INDIANA

Indiana Department of Natural Resources

402 W. Washington Street, Room W264

Indianapolis, IN 46204-2748

Phone: (317) 234-1107

Fax: (317) 233-4579

<http://www.state.in.us/dnr/>

IOWA

Iowa Department of Natural Resources

Wallace State Office Building

Des Moines, IA 50319

Phone: (515) 281-8942

Fax: (515) 281-8895

<http://www.iowadnr.com/>

KANSAS

Department of Agriculture

109 SW 9th Street, 2nd Floor

Topeka, KS 66612-1283

Phone: (785) 296-5440

Fax: (785) 296-4835

<http://www.ksda.gov/>

KENTUCKY

Division of Water

14 Reilly Road

Frankfort, KY 40601

Phone: (502) 564-3410

Fax: (502) 564-9003

<http://www.water.ky.gov/>

LOUISIANA

Louisiana Department of Transportation and Development

Office of Public Works

Floodplain Management Section

1201 Capitol Access Road

P.O. Box 94245, Capitol Station

Baton Rouge, LA 70804-9245

Phone: (225) 274-4354

Fax: (225) 274-4351

<http://www.dotd.state.la.us/>

MAINE**State Planning Office**

184 State Street (street)
38 State House Station (mailing)
Augusta, ME 04333-0038
Phone: (207) 287-8063
Fax: (207) 287-6489
<http://www.state.me.us/spo/>

MARYLAND**Department of the Environment**

1800 Washington Boulevard, Suite 430
Baltimore, MD 21230
Phone: (410) 537-3775
Fax: (410) 537-3751
<http://www.mde.state.md.us/>

MASSACHUSETTS**Department of Conservation and Recreation**

Flood Hazard Management
251 Causeway Street, Suite 700
Boston, MA 02114
Phone: (617) 626-1406
Fax: (617) 626-1349
<http://www.mass.gov/dcr/>

MICHIGAN**Department of Environmental Quality**

525 West Allegan Street
P.O. Box 30473
Lansing, MI 48909-7958
Phone: (517) 373-7917
Fax: (517) 373-9965
<http://www.michigan.gov/deq>

MINNESOTA**Department of Natural Resources**

500 LaFayette Road, Box 32
St. Paul, MN 55515-4032
Phone: (651) 259-5713
Fax: (651) 296-0445
<http://www.dnr.state.mn.us/>

MISSISSIPPI

Emergency Management Agency

Office of Mitigation
1 Mema Drive
P.O. Box 5644
Pearl, MS 39208
Phone: (601) 933-6884
Fax: (601) 933-6805
<http://www.msema.org/>

MISSOURI

State Emergency Management Agency

2302 Militia Drive
P.O. Box 116
Jefferson City, MO 65102
Phone: (573) 526-9141
Fax: (573) 526-9198
<http://sema.dps.mo.gov/>

MONTANA

Montana Department of Natural Resources and Conservation

Floodplain Management Program
1424 9th Avenue
Helena, MT 59620-1601
Phone: (406) 444-6654
Fax: (406) 444-0533
http://dnrc.mt.gov/wrd/water_op/floodplain/default.asp

NEBRASKA

Department of Natural Resources

301 Centennial Mall South
Lincoln, NE 68509-4876
Phone: (402) 471-3932
Fax: (402) 471-2900
<http://www.dnr.ne.gov/>

NEVADA

Division of Water Resources

901 South Stewart Street, Suite 2002
Carson City, NV 89701
Phone: (775) 684-2884
Fax: (775) 684-2811
<http://water.nv.gov/>

NEW HAMPSHIRE**Office of Energy and Planning**

4 Chenell Drive, 2nd Floor
Concord, NH 03301
Phone: (603) 271-1762
Fax: (603) 271-2615
<http://www.nh.gov/oep/>

NEW JERSEY**Department of Environmental Protection**

401 East State Street
P.O. Box 419
Trenton, NJ 08625
Phone: (609) 984-0859
Fax: (609) 984-1908
<http://www.state.nj.us/dep/>

NEW MEXICO**Department of Homeland Security and Emergency Management**

13 Bataan Boulevard
P.O. Box 1628
Santa Fe, NM 87504-1628
Phone: (505) 476-9617
Fax: (505) 471-9695
<http://www.nmdhsem.org/>

NEW YORK**Department of Environmental Conservation**

625 Broadway
Albany, NY 12233-3507
Phone: (518) 402-8146
Fax: (518) 402-9029
<http://www.dec.ny.gov/>

NORTH CAROLINA**Department of Crime Control and Public Safety**

Division of Emergency Management
1812 Tillery Place, Suite 105
Raleigh, NC 27604-1356
Phone: (919) 715-5711
Fax: (919) 715-0408
<http://www.ncem.org/>

NORTH DAKOTA

State Water Commission

900 East Boulevard Avenue
Bismark, ND 58505-0850
Phone: (701) 328-4898
Fax: (701) 328-3747
<http://www.swc.state.nd.us/>

OHIO

Department of Natural Resources

2045 Morse Road, Building B-2
Columbus, OH 43229
Phone: (614) 265-6752
Fax: (614) 265-6767
<http://www.dnr.state.oh.us/>

OKLAHOMA

Water Resources Board

3800 North Classen
Oklahoma City, OK 73118
Phone: (918) 581-2924
Fax: (405) 530-8900
<http://www.owrb.ok.gov/>

OREGON

Department of Land Conservation Development

635 Capitol Street, NE, Suite 150
Salem, OR 97301-2540
Phone: (503) 373-0050
Fax: (503) 375-5518
<http://www.lcd.state.or.us/>

PENNSYLVANIA

Department of Community and Economic Development

Commonwealth Keystone Building
400 North Street, 4th Floor
Harrisburg, PA 17120-0225
Phone: (717) 720-7396
Fax: (717) 783-1402
<http://www.newpa.com/>

PUERTO RICO

Planning Board

Centro Gubernamental Roberto Sanchez Vilella
P.O. Box 41119, Minillas Station
Santurce, PR 00940-90985
Phone: (787) 727-4444
Fax: (787) 268-6858
<http://www.jp.gobierno.pr/>

RHODE ISLAND

Emergency Management Agency

645 New London Avenue
Cranston, RI 02920
Phone: (401) 462-7048
Fax: (401) 944-1891
<http://www.riema.ri.gov/>

SOUTH CAROLINA

Department of Natural Resources

1000 Assembly Street, Suite 345C
P.O. Box 167
Columbia, SC 29201
Phone: (803) 734-9120
Fax: (803) 734-9106
<http://www.dnr.sc.gov/>

SOUTH DAKOTA

Office of Emergency Management

118 West Capitol Avenue
Pierre, SD 57501
Phone: (605) 883-3238
Fax: (605) 773-3580
<http://www.oem.sd.gov/>

TENNESSEE

Department of Economic and Community Development

Tennessee Tower Building
312 8th Avenue North, 10th Floor
Nashville, TN 37243-0607
Phone: (615) 741-2211
Fax: (615) 741-0607
http://www.state.tn.us/ecd/bizdev_idg.htm

TEXAS

Water Development Board

1700 North Congress Avenue
P.O. Box 13231
Austin, TX 78711-3231
Phone: (512) 463-3509
Fax: (512) 475-2053
<http://www.twdb.state.tx.us/>

UTAH

Department of Public Safety

Division of Comprehensive Emergency Management
State Office Building, Room 1110
Salt Lake City, UT 84114
Phone: (801) 538-3332
Fax: (801) 538-3772
<http://www.cem.utah.gov/>

VERMONT

Department of Environmental Conservation

103 South Main Street, Building 10 N
Waterbury, VT 05671
Phone: (802) 241-1554
Fax: (802) 244-5141
<http://www.anr.state.vt.us/dec/dec.htm>

VIRGIN ISLANDS

Department of Planning and Natural Resources

C.E. King Airport, Terminal Building 2nd Floor
St. Thomas, VI 00802
Phone: (340) 774-3320
Fax: (340) 775-5706
<http://www.dpnr.gov.vi/>

VIRGINIA

Department of Conservation and Historic Resources

Division of Dam Safety and Floodplain Management
203 Governor Street, Suite 206
Richmond, VA 23219
Phone: (804) 786-3914
Fax: (804) 371-2630
<http://www.dcr.virginia.gov/>

WASHINGTON**Department of Ecology**

P.O. Box 47690
Olympia, WA 98504-7600
300 Desmond Drive, SE
Lacey, WA 98503
Phone: (360) 407-6796
Fax: (360) 407-6902
<http://www.ecy.wa.gov/>

WEST VIRGINIA**Division of Homeland Security and Emergency Management**

Capitol Building 1, Room EB-80
1900 Kanawha Boulevard
Charleston, WV 25305-0360
Phone: (304) 965-2331
Fax: (304) 965-3216
<http://www.wvdhsem.gov/>

WISCONSIN**Department of Natural Resources**

101 South Webster
Madison, WI 53702
Phone: (608) 266-8037
Fax: (608) 266-3093
<http://dnr.wi.gov/>

WYOMING**Office of Homeland Security**

Herschler Building, 1st East
122 West 25th Street
Cheyenne, WY 82002
Phone: (307) 777-4910
Fax: (307) 635-6017
<http://wyohomelandsecurity.state.wy.us/main.aspx>

Appendix E

State Historic Preservation Offices

ALABAMA

Alabama Historical Commission

468 South Perry Street
P.O. Box 300900
Montgomery, AL 36130-0900
Phone: (334) 230-2690
<http://www.preserveala.org>

ALASKA

Alaska Department of Natural Resources

Office of History and Archeology
550 West 7th Avenue, Suite 1310
Anchorage, AK 99501-3565
Phone: (907) 269-8721
Fax: (907) 269-8908
<http://www.dnr.state.ak.us/parks/oha/index.htm>

ARIZONA

Arizona State Parks

1300 West Washington
Phoenix, AZ 85007
Phone: (602) 542-4009
<http://www.pr.state.az.us/partnerships/shpo/shpo.html>

ARKANSAS

Arkansas Historic Preservation Program

1500 Tower Building
323 Center Street
Little Rock, AR 72201
Phone: (501) 324-9880
Fax: (501) 324-9184
<http://www.arkansaspreservation.org/>

CALIFORNIA

Office of Historic Preservation

Department of Parks and Recreation
1416 9th Street, Room 1442

P.O. Box 942896
Sacramento, CA 94296-0001
Phone: (916) 653-6624
Fax: (916) 653-9824
<http://ohp.parks.ca.gov/>

COLORADO

Colorado Historical Society
Office of Archaeology and Historic Preservation
1300 Broadway
Denver, CO 80203
Phone: (303) 866-2136
Fax: (303) 866-2711
<http://www.coloradohistory-oahp.org>

CONNECTICUT

Connecticut Commission on Culture and Tourism
Historic Preservation and Museum Division
One Constitution Plaza, 2nd Floor
Hartford, CT 06103
Phone: (860) 256-2800
Fax: (860) 256-2811
<http://www.chc.state.ct.us>

DELAWARE

Division of Historical and Cultural Affairs
21 The Green
Dover, DE 19901
Phone: (302) 736-7400
Fax: (302) 739-5660
<http://www.state.de.us/shpo/index.htm>

DISTRICT OF COLUMBIA

Office of Planning
801 North Capitol Street, NE., Suite 4000
Washington, DC 20002
Phone: (202) 442-7600
<http://planning.dc.gov/planning/site/default.asp>

FLORIDA

Division of Historical Resources
R. A. Gray Building
500 South Bronough Street
Tallahassee, FL 32399-0250

Phone: (850) 245-6333
<http://www.flheritage.com/>

GEORGIA

Department of Natural Resources
Historic Preservation Division
34 Peachtree Street, NW, Suite 1600
Atlanta, GA 30303
Phone: (404) 656-2840
Fax: (404) 657-1046
<http://www.gashpo.org/>

HAWAII

Department of Land and Natural Resources
State Historic Preservation Division
Kakuhihewa Building
601 Kamokila Boulevard, Suite 555
Kapolei, HI 96707
Phone: (808) 692-8015
Fax: (808) 692-8020
<http://www.hawaii.gov/dlnr/hpd/hpgreeting.htm>

IDAHO

Idaho State Historical Society
2205 Old Penitentiary Road
Boise, ID 83712
Phone: (208) 334-2682
Fax: (208) 334-2774
<http://www.idahohistory.net/shpo.html>

ILLINOIS

Illinois Historic Preservation Agency
1 Old State Capitol Plaza
Springfield, IL 62701-1507
Phone: (217) 782-4836
<http://www.state.il.us/hpa/ps/>

INDIANA

Department of Natural Resources
Division of Historic Preservation and Archaeology
402 West Washington Street, Room W274
Indianapolis, IN 46204-2739
Phone: (317) 232-1646
<http://www.state.in.us/dnr/historic/>

IOWA

State Historical Society of Iowa

600 East Locust
Des Moines, IA 50319
Phone: (515) 281-6200
<http://www.iowahistory.org>

KANSAS

Kansas State Historical Society

6425 SW 6th Avenue
Topeka, KS 66615
Phone: (785) 272-8681
Fax: (785) 272-8682
<http://www.kshs.org/resource/buildings.htm>

KENTUCKY

Kentucky Heritage Council

300 Washington Street
Frankfort, KY 40601
Phone: (502) 564-7005
Fax: (502) 564-5820
<http://heritage.ky.gov/>

LOUISIANA

Division of Historic Preservation

Office of Cultural Development
Department of Culture, Recreation and Tourism
1051 North Third Street
P.O. Box 44247
Baton Rouge, LA 70804
Phone: (225) 342-8160
Fax: (225) 219-9772
<http://www.crt.state.la.us/hp/>

MAINE

Maine Historic Preservation Commission

55 Capitol Street
65 State House Station
Augusta, ME 04333-0065
Phone: (207) 289-2132
<http://www.state.me.us/mhpc/>

MARYLAND**Maryland Historical Trust**

100 Community Place
Crownsville, MD 21032-2023
Phone: (410) 514-7600
Fax: (410) 514-7678
<http://www.marylandhistoricaltrust.net/>

MASSACHUSETTS**Massachusetts Historical Commission**

Department of the Commonwealth
220 Morrissey Boulevard
Boston, MA 02125-3314
Phone: (617) 727-8470
Fax: (617) 727-5128
<http://www.sec.state.ma.us/mhc/mhcidx.htm>

MICHIGAN**Department of History, Arts, and Libraries**

702 West Kalamazoo Street
P.O. Box 30738
Lansing, Michigan 48909-8238
Phone: (517) 241-2236
Fax: (517) 241-2930
<http://www.michigan.gov/hal>

MINNESOTA**Minnesota Historical Society**

345 West Kellogg Boulevard
St. Paul, MN 55102-1906
Phone: (651) 259-3000
<http://www.michigan.gov/hal>

MISSISSIPPI**Department of Archives and History**

200 North Street
P.O. Box 571
Jackson, MS 39205-0571
Phone: (601) 576-6850
Fax: (601) 576-6876
<http://mdah.state.ms.us/>

MISSOURI

Department of Natural Resources

205 Jefferson
P.O. Box 176
Jefferson City, MO 65102
Phone: (573) 751-7858
<http://www.dnr.mo.gov/shpo/>

MONTANA

State Historic Preservation Office

Montana Historical Society
1410 Eighth Avenue
Helena, MT 59620
Phone: (406) 444-7715
<http://www.montanahistoricalociety.com/shpo/default.asp>

NEBRASKA

Nebraska State Historical Society

P.O. Box 82554
1500 R Street
Lincoln, NE 68501
Phone: (402) 471-3270
<http://www.nebraskahistory.org/>

NEVADA

Nevada State Historic Preservation Office

100 North Stewart Street
Carson City, NV 89701
Phone: (702) 684-3448
<http://www.nevadaculture.org/>

NEW HAMPSHIRE

Division of Historical Resources

19 Pillsbury Street, 2nd Floor
Concord, NH 03301-3570
Phone: (603) 271-3483
Fax: (603) 271-3433
<http://www.nh.gov/nhdhr/>

NEW JERSEY

Historic Preservation Office

Department of Environmental Protection
401 E. State Street

P.O. Box 404
Trenton, NJ 08625-0404
Phone: (609) 984-0176
Fax: (609) 984-0578
<http://www.state.nj.us/dep/hpo/>

NEW MEXICO

Historic Preservation Division
Department of Cultural Affairs
Bataan Memorial Building
407 Galisteo Street, Suite 236
Santa Fe, NM 87501
Phone: (505) 827-6320
Fax: (505) 827-6338
<http://www.nmhistoricpreservation.org/>

NEW YORK

State Historic Preservation Office
Peebles Island
P.O. Box 189
Waterford, NY 12188-0189
Phone: (518) 237-8643
<http://nysparks.state.ny.us/shpo/>

NORTH CAROLINA

State Historic Preservation Office
Office of Archives and History
Department of Cultural Resources
109 East Jones Street
Raleigh, NC 27699
Phone: (919) 807-6570
Fax: (919) 807-6599
<http://www.hpo.ncdcr.gov/>

NORTH DAKOTA

State Historical Society of North Dakota
Heritage Center
612 East Boulevard Avenue
Bismarck, ND 58505-0830
Phone: (701) 328-2672
Fax: (701) 328-3710
<http://www.nd.gov/hist/ahp.htm>

OHIO

Ohio Historical Society

Historic Preservation Office
567 East Hudson Street
Columbus, OH 43211-1030
Phone: (614) 298-2000
Fax: (614) 298-2037
<http://www.ohiohistory.org/resource/histpres/>

OKLAHOMA

State Historic Preservation Office

Oklahoma Historical Society
2401 North Laird Avenue
Oklahoma City, OK 73105
Phone: (405) 521-6249
Fax: (405) 522-0816
<http://www.okhistory.org/shpo/shpom.htm>

OREGON

Parks and Recreation Department

Heritage Programs
725 Summer Street NE, Suite C
Salem, OR 97301
Phone: (503) 986-0671
Fax: (503) 986-0793
<http://egov.oregon.gov/OPRD/HCD/>

PENNSYLVANIA

Pennsylvania Historical and Museum Commission

300 North Street
Harrisburg, PA 17120
Phone: (717) 787-3362
Fax: (717) 783-9924
<http://www.portal.state.pa.us/portal/server.pt?open=512&mode=2&objID=1426>

PUERTO RICO

Calle Norzagaray Final Cuartel de Ballaja, 3^{er} Piso

San Juan, PR 00906-6581
Phone: (787) 721-3737
Fax: (787) 721-3773
<http://www.gobierno.pr/OECH/index.htm>

RHODE ISLAND

Rhode Island Historical Preservation and Heritage Commission

Old State House
150 Benefit Street
Providence, RI 02903
Phone: (401) 222-2678
Fax: (401) 222-2968
<http://www.preservation.ri.gov/>

SOUTH CAROLINA

State Historic Preservation Office

Department of Archives and History
8301 Parklane Road
Columbia, SC 29223
Phone; (803) 896-6178
Fax: (803) 896-6167
<http://shpo.sc.gov/>

SOUTH DAKOTA

State Historic Preservation Office

State Historical Society
900 Governors Drive
Pierre, SD 57501-2217
Phone: (605) 773-3458
Fax: (605) 773-6041
<http://www.sdhistory.org/HP/histpres.htm>

TENNESSEE

Tennessee Historical Commission

Department of Environment and Conservation
2941 Lebanon Road
Nashville, TN 37243-0442
Phone: (615) 532-1550
<http://www.tennessee.gov/environment/hist/>

TEXAS

Texas Historical Commission

1511 Colorado
P.O. Box 12276
Austin, TX 78711-2276
Phone: (512) 463-6100
Fax: (512) 463-8222
<http://www.thc.state.tx.us>

UTAH

Utah State History

300 South Rio Grande Street
Salt Lake City, UT 84101
Phone: (801) 533-3500
Fax: (801) 533-3567
<http://history.utah.gov/>

VERMONT

Division for Historic Preservation

National Life Building, 2nd Floor
Montpelier, VT 05620-1201
Phone: (802) 828-3213
Fax: (803) 828-3206
<http://www.historicvermont.org/>

VIRGINIA

Department of Historic Resources

2801 Kensington Avenue
Richmond, VA 23221
Phone: (804) 367-2323
<http://www.dhr.virginia.gov/>

WASHINGTON

Department of Archeology and Historic Preservation

1063 South Capitol Way, Suite 106
Olympia, WA 98501
Phone: (360) 586-3065
<http://www.dahp.wa.gov/>

WEST VIRGINIA

West Virginia Division of Culture and History

Historic Preservation Office
Cultural Center
1900 Kanawha Boulevard East
Charleston, WV 25305-0300
Phone: (304) 558-0220
Fax: (304) 558-2779
<http://www.wvculture.org/>

WISCONSIN**Historic Preservation Division**

State Historical Society of Wisconsin
816 State Street
Madison, WI 53706-1417
Phone: (608) 264-6493
<http://www.wisconsinhistory.org/hp/>

WYOMING**Wyoming State Historic Preservation Office**

Barrett Building
2301 Central Avenue
3rd Floor
Cheyenne, WY 82002
Phone: (307) 777-7697
Fax: (307) 777-6421
<http://wyoshpo.state.wy.us/>

AMERICAN SAMOA

c/o Executive Offices of the Governor American Samoa
Historic Preservation Office American Samoa Government
Pago Pago, American Samoa 96799
Phone: (684) 699-2316
Fax: (684) 699-2276
<http://www.ashpo.org/index.htm>

VIRGIN ISLANDS**State Historic Preservation Office**

Nisky Center
17 Kongens Gade
St. Thomas, VI 00802
Phone: (340) 776-8605
Fax: (340) 776-7236
<http://www.dpnr.gov.vi/historic.htm>

Appendix F

Professional Organizations

The organizations listed below can provide information about registered design professionals and licensed contractors in or near the area where you live.

American Institute of Architects (AIA)

1735 New York Avenue, NW.
Washington, DC 20006-5292
Phone: (202) 626-7300 or (800) 242-3837
Fax: (202) 626-7547
<http://www.aia.org>

American Society of Civil Engineers (ASCE)

International Headquarters
1801 Alexander Bell Drive
Reston, VA 20191-4400
Phone: (703) 295-6300 or (800) 548-2723
Fax: (703) 295-6319
<http://www.asce.org>

Association of State Floodplain Managers (ASFPM)

2809 Fish Hatchery Road
Madison, WI 53713
Phone: (608) 274-0123
Fax: (608) 274-0696
<http://www.floods.org>

International Association of Structural Movers (IASM)

1223 Morning Shore Drive, Suite 200
P.O. Box 2637
Lexington, SC 29071
Phone: (803) 951-9304
Fax: (803) 951-9314
<http://www.iasm.org>

Institute for Business and Home Safety (IBHS)

4775 E. Fowler Avenue

Tampa, FL 33617

Phone: (813) 286-3400

Fax: (813) 286-9960

<http://www.disastersafety.org>

International Code Council (ICC)

Headquarters

500 New Jersey Avenue, NW., 6th Floor

Washington, DC 20001-2070

Phone: (888) 422-7233

Fax: (202) 599-9871

<http://www.iccsafe.org>

National Association of Home Builders (NAHB)

1201 15th Street, NW.

Washington, DC 20005

Phone: (202) 266-8200 or (800) 368-5242

Fax: (202) 266-8400

<http://www.nahb.org>



FEMA

FEMA P-312
Catalog No. 09349-6